



Technical Guide

TG-19-C-001-E

D

Made by: pelrom

Date: 29.12.2008

3

Modifications: see last page

# CALIBRE 2627

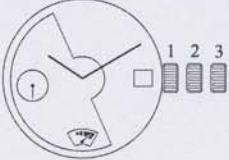
	Version A	Version B
$11\frac{1}{2}'''$ Ø 25,60 mm		
Height on movement	5.35 mm	
Power reserve	44 h	48 h
Number of jewels	29	29
Frequency	4 Hz (28'800 A/h)	3.5 Hz (25'200 A/h)



Automatic movement with Co-Axial escapement, date, power reserve, COSC certified,  
Omega balance system without index.

Calibre 2627	1
General Information for Calibre 2627	3-4
Date correction / Mandatory exchange on version A / Improvements on version B	3
Balance bridge complete / Type of intervention and the required	3
«Measure Instrument» / Fitting of hands / Tools / Lubricants	3
Technical modifications on version «B»	4
Differences between versions 2627A and 2627B	5-6
Differences between versions	5
Differences between versions	6
Exploded view for Calibre 2627	7-11
Dial side	7
Movement side	8
Dial side	9
Dial side	10
Movement side	11
List & Spare parts list for Calibre 2627	12-15
List & Spare parts list	12
List & Spare parts list	13
List & Spare parts list	14
List & Spare parts list	15
Specific Informations for Calibre 2627	16-20
Assembling of the escapement system	16
Assembling of the balance bridge / Disassembling of the balance bridge	16
Function of the Power reserve	17
Setting of «Power Reserve hand» / Runners for hand setting and hand setting force	18
Epilame	19
Adjustment key	20
Modifications of Technical Guide for Calibre 2627	21

## General Information for Calibre 2627

### Date correction

Date correction should not be performed between 10 pm and 2 am.

### Co-Axial Escapement lubricants

See Working Instruction No 40.

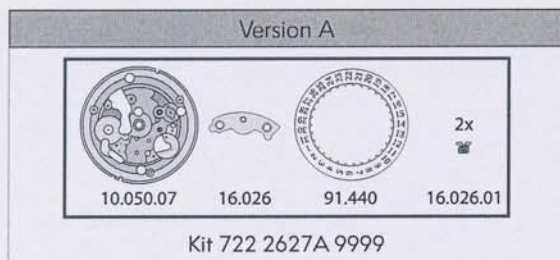

### Mandatory exchange on version A (Kit Date indicator system)

As soon as a part mentioned below is ordered, the **KIT ref. 722 2627A 9999** will be automatically activated. Additional train wheel bridge ref. 722 2627B 10.050.07 Power reserve indicator bridge ref. 722 2627B 16.026 Screw for power reserve indicator bridge ref. 722 2627B 16.026.01

Date Indicator for window ref. 722 2627 91.440\*

Version A	Version B
Quality of adjustment: Good	Quality of adjustment: Improved
Self-starting: Medium	Self-starting: Good

### Improvements on version B

### Balance bridge complete (ref. 10.058°)

The balance bridge is not available. (see CS-Info Calibre No 33).

### Type of intervention and the required «Measure Instrument»

Intervention	Required minimum equipment	Comments
<b>Complete or Partial maintenance service</b> Co-Axial 3.5 Hz & 4 Hz	- Watch Expert II + III (white case) - Chronoscope M1 (up-dated version) - Chronoscope S1, X1	
<b>Rate adjustment on a new watch:</b> (Co-Axial 3.5 Hz & 4 Hz)	- Watch Expert (red case) - Wicometer Professional - Chronoscope M1 (old version)	<b>Important: The amplitude will not be correctly indicated. For rate adjustment only, this can be accepted!</b>

### Hand fitting

To fit the hands, the movement must be placed in a suitable, well-adjusted movement holder.

### Tools

Tools	Reference
Kit of tool for hand-fitting	507 0011
Ball bearing set	502 S03 SET
Movement holder for hand fitting	507 0017
Mainspring winder No 6.	502 150 0009
Rate adjustment key	502 200 0501
Tool for checking the escapement function	506 0002
Key cam for rotor	502 200 0361
Support for rotor	502 100 0381

### Lubricants











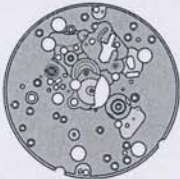
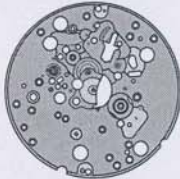



Lubricants	Reference
Moebius SYNT-A-LUBE 9010 (2ml)	504 200 0001
Moebius D5	504 200 0013
Moebius SYNT HP-500	504 5012
Moebius SYNT HP-1300 Sans Colorant	504 5013
Moebius 9504	504 100 0011
Molycote DX	504 100 0052





















Technical modifications on version «B»

Intermediate escape wheel				
Old version	Risk	New version	Improvements	Notes
7222627B30039	Black residues within the engagement can cause low amplitude or a stop of the watch. The old version is yellow.	7222627B30039	Improvement of surface and material. The new version is grey. Available since 21/2008.	The new version must automatically be assembled if black residues within the engagement are visible.
				

## Differences between version 2627A and 2627B

	2627A (4 Hz)	2627B (3.5 Hz)
Main plate	 ref. 72226271002007 Engraved 2627A	 ref. 7222627B1002007 Engraved 2627B
Additional train wheel bridge	 ref. 722262A1005007 Without bearing for date indicator carrier wheel  (see page 3)	 ref. 7222627B1005007 With bearing for the date indicator carrier wheel. Improvement of the guiding for the date indicator (not visible).
Power reserve indicator bridge	 ref. 722262716026	 ref. 7222627B16026 Improvement of the guiding for the date indicator. Identifiable by a 2 stamped on the back of the bridge.
Second wheel	 ref. 722262730027 96 theeth with 8 arms	 ref. 7222627B30027 105 theeth with 5 arms
Additional second wheel	 ref. 722262730030 96 theeth	 ref. 7222627B30030 84 theeth
Intermediate escape wheel	 ref. 722262730039 Pinion with 8 leaves	 ref. 7222627B30039 Pinion with 10 leaves Nick on the upper side of the pivot shank.
Co-Axial wheel	 ref. 7222500B30040 $\varnothing$ pinion = 1.999 mm	 ref. 7222500C30040 $\varnothing$ pinion = 2.119 mm
Screw for power reserve indicator	 ref. 72226271602601	 ref. 7222627B1602601

## Differences between version 2627A and 2627B

	2627A (4 Hz)	2627B (3.5 Hz)	
Stop lever	 ref. 722250056070	 ref. 7222500C56070	
Barrel complete	 ref. 722262720010	 ref. 7222627B20010	
Mainspring	 ref. 7222500B20102	 ref. 722112020102	
Pallet fork	 ref. 7222500B40010 Old shape	 ref. 7222500B40010 New shape	 ref. 7222500C40010
Balance complete with stud	 ref. 7222500B4005021 Diameter 7.2 (mgcm <sup>2</sup> ) Thickness of balance rim 8.54 mm Pivots 0.37 mm 0.08 mm cylindrical	 ref. 7222500C4005021 Diameter 9.4 (mgcm <sup>2</sup> ) Thickness of balance rim 8.70 mm Pivots 0.45 mm 0.07 mm conical	
Jewelled shock-absorber, top	 ref. 722112070530 0.09 mm = Ø pivot hole	 ref. 7222500C70530 0.08 mm = Ø pivot hole	
Jewelled shock-absorber, bottom	 ref. 722112070531 0.09 mm = Ø pivot hole	 ref. 7222500C70531 0.08 mm = Ø pivot hole	
In settings, upper	 ref. 722112070640 0.09 mm = Ø pivot hole	 ref. 7222500C70640 0.08 mm = Ø pivot hole	
In settings,, bottom	 ref. 722112070641 0.09 mm = Ø pivot hole	 ref. 7222500C 70641 0.08 mm = Ø pivot hole	

## Exploded view - Dial side for Calibre 2627

### Parts listed in order of assembly

1 = 1002007	10 = 31083
2 = 31120	11 = 31041
3 = 311211	12 = 31100
4 = 5101021	13 = 31101
5 = 53022	14 = 10062
6 = 51080.06	15 = 3503 (1x)
7 = 51050	16 = 10055
8 = 51091	17 = 1005501
9 = 3503	

- Moebius SYNT HP-1300 Sans Colorant
- Moebius SYNT HP-1300 Sans Colorant
- ▲ Moebius 9405
- ▼ Moebius 9010

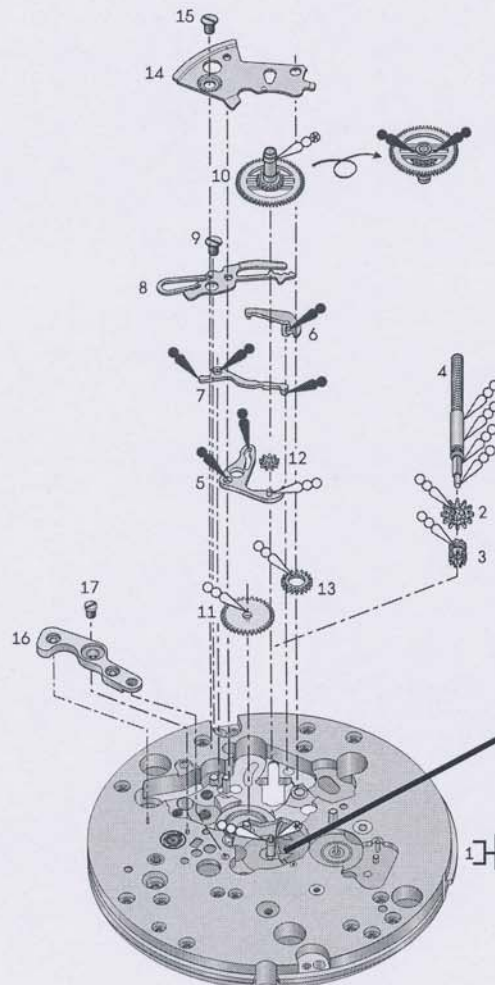

**Additional lubrication:**  
See CS-Info Calibre No 32

Lubrication spot (Moebius 9010, small quantity)  
at the exit of second wheel axle - centre tube.

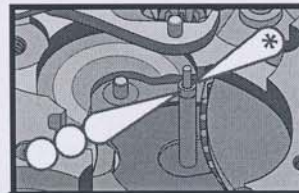





1 Versions A + B  
see page 5

# Exploded view - Movement side for Calibre 2627

## Parts listed in order of assembly

1 = 1004107	14 = 30039
2 = 32033	15 = 30025
3 = 31023	16 = 30027
4 = 31024	17 = 1004807
5 = 31021	18 = 3505 (1x)
6 = 51120	19 = 30040
7 = 81036	20 = 40010
8 = 3509 (1x)	21 = 1005707
9 = 30012	22 = 3511 (1x)
10 = 20010	23 = 3511 (1x)
11 = 31020	24 = 1005824
12 = 1004107	25 = 4005021
13 = 3503 (3x)	

-  Moebius SYNT-A-LUBE 9010
-  Moebius SYNT HP-1300 Sans Colorant
-  Moebius SYNT HP-500
-  Moebius SYNT HP-1300 Sans Colorant
-  Kluber P125

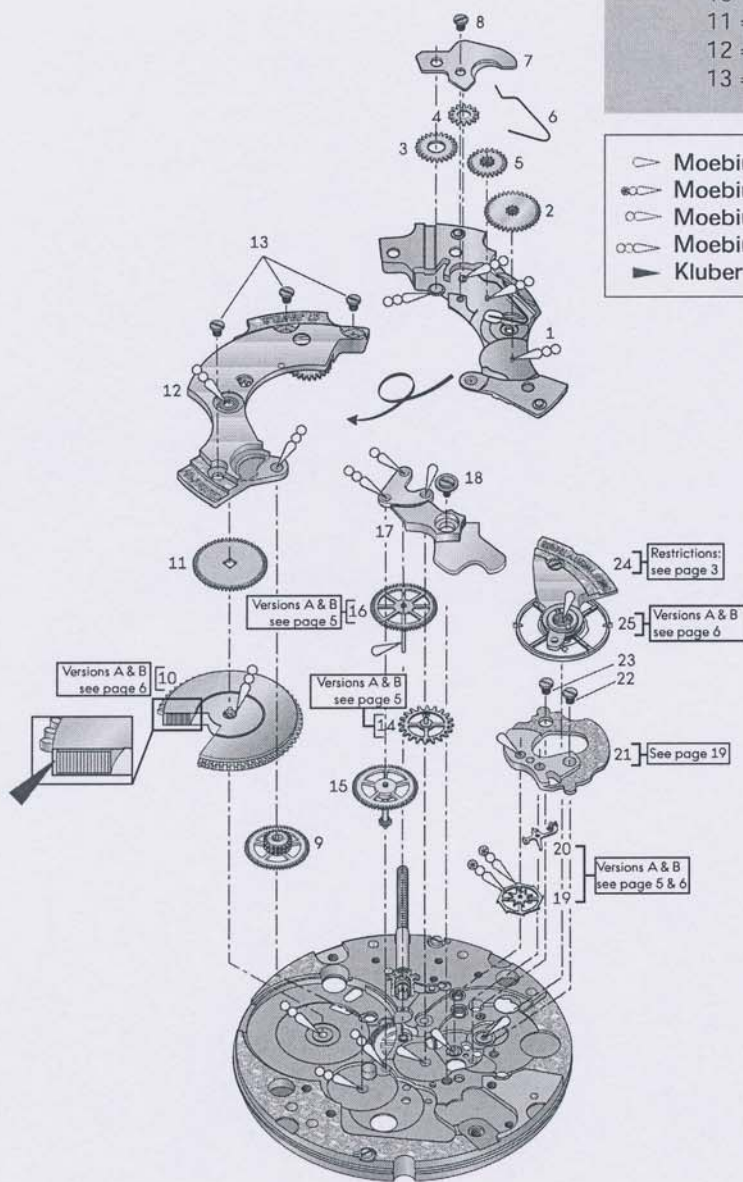





# Exploded view - Dial side for Calibre 2627

## Parts listed in order of assembly

- |             |             |
|-------------|-------------|
| 1 = 36010   | 5 = 36057   |
| 2 = 66150   | 6 = 30030   |
| 3 = 6615001 | 7 = 1005007 |
| 4 = 36055   | 8 = 1005001 |

-  Moebius SYNT-A-LUBE 9010
-  Moebius SYNT HP-1300 Sans Colorant
-  Molycote DX

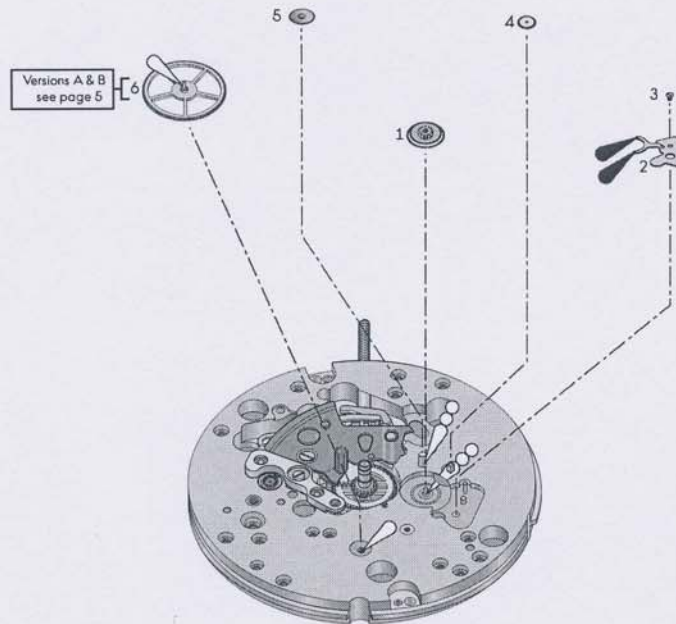
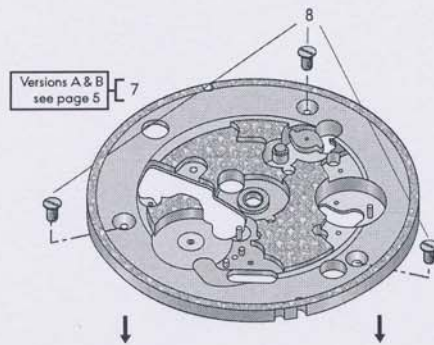

Exploded view - Dial side for Calibre 2627

Parts listed in order of assembly

1 = 91420	6b = 33011
2 = 33020	7 = 13111
3 = 91440	8 = 1311101
4 = 16026 (2x)	9 = 10062
5 = 1602601	10 = 3503 (1x)
6a = 53080	11 = 31046063

 Moebius SYNT HP-1300 Sans Colorant

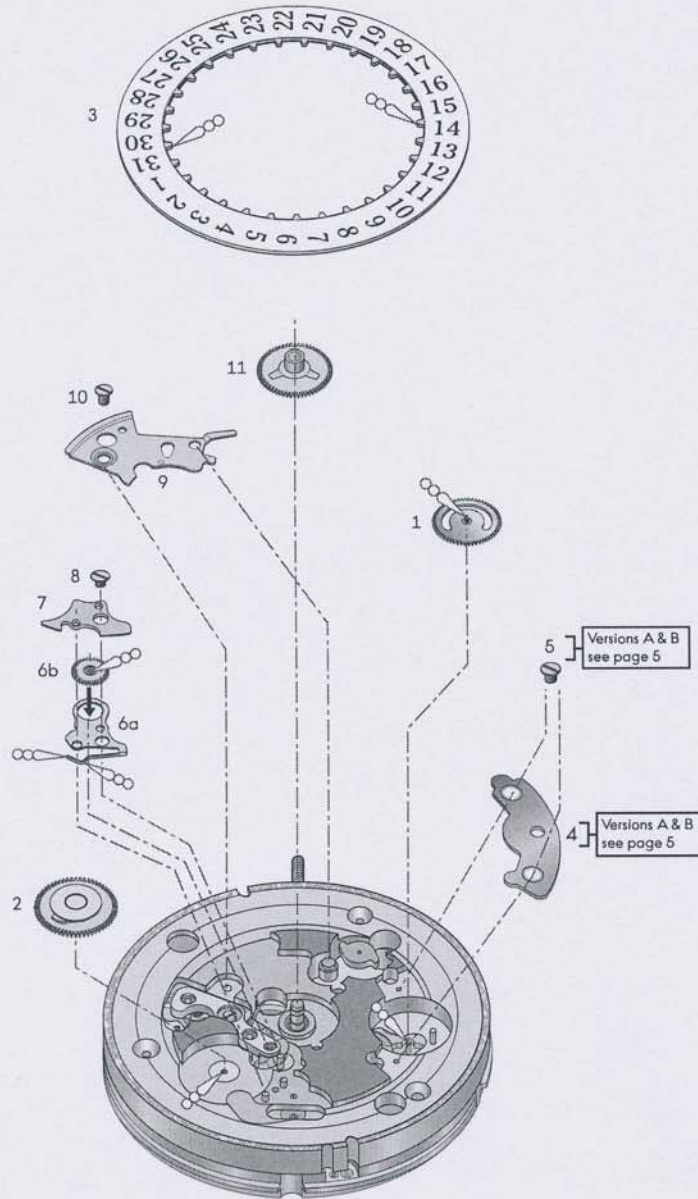



# Exploded view - Movement side for Calibre 2627

## Parts listed in order of assembly







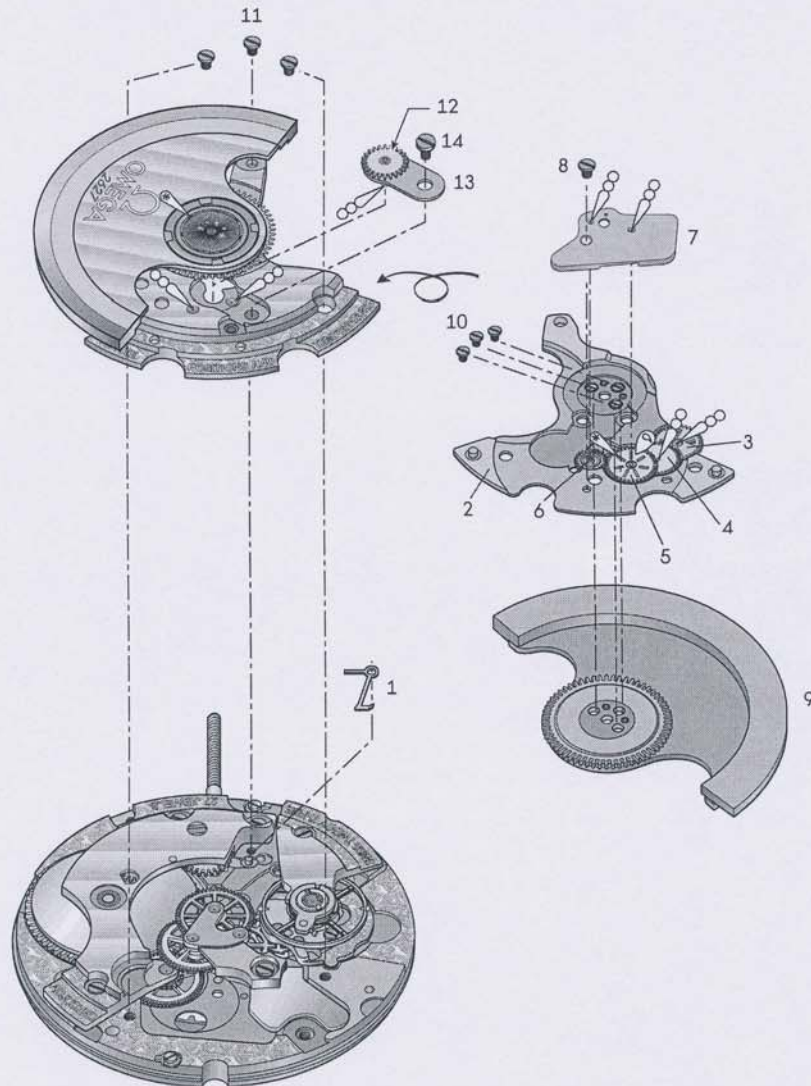



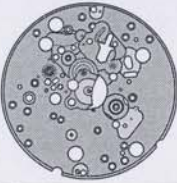





1 = 56070	8 = 3504 (1x)
2 = 1203007	9 = 2201006
3 = 32032	10 = 3507 (3x)
4 = 32031	11 = 3503 (3x)
5 = 32037	12 = 52041
6 = 52040	13 = 12124
7 = 1205107	14 = 3506 (1x)

 See CS-Info No. 26    **Lubeta V105**  
 When **Lubeta V105** is available do not  
 use **Moebius 9010**.









 **Moebius SYNT-A-LUBE 9010**  
 **Moebius SYNT HP-1300 Sans Colorant**































## Lists & Spare parts lists for Calibre 2627

Main plate, jewelled, assembled	Version	Reference	Dial fastener	Version	Reference
	2627A	72226271002007		2627A	722112010300
	2627B	7222627B1002007		2627B	
Barrel bridge, jewelled	Version	Reference	Automatic bridge, jewelled	Version	Reference
	2627A	72226271004107		2627A	7222500B1203007
	2627B			2627B	
Wheel train bridge, jewelled	Version	Reference	Automatic device lower bridge	Version	Reference
	2627A	7222500B1004807		2627A	72211201205107
	2627B			2627B	
Additional train wheel bridge, bushing	Version	Reference	Reverser maintaining plate	Version	Reference
	2627A	72226271005007		2627A	722112012124
	2627B	7222627B1005007		2627B	
Intermediate escape wheel bridge	Version	Reference	Date jumper maintaining plate	Version	Reference
	2627A	722262710055		2627A	722262713111
	2627B			2627B	
Pallet bridge	Version	Reference	Power reserve indicator bridge	Version	Reference
	2627A	72225001005707		2627A	722262716026
	2627B			2627B	7222627B16026
Balance bridge, complete	Version	Reference	Barrel complete	Version	Reference
	2627A	722262710058° (voir page 3)		2627A	722262720010
	2627B			2627B	7222627B20010
Minute bridge	Version	Reference	Barrel drum and cover	Version	Reference
	2627A	722262710062		2627A	722262720030
	2627B			2627B	
Minute train bridge	Version	Reference	Barrel arbor	Version	Reference
	2627A	722112010062		2627A	722262720060
	2627B			2627B	

## Lists & Spare parts lists for Calibre 2627

Mainspring	Version	Reference	Intermediate ratchet wheel	Version	Reference
	2627A	7222500B20102		2627A	722112031021
	2627B	722112020102		2627B	
Oscillating weight assembled	Version	Reference	Crown wheel	Version	Reference
	2627A	72226272201006		2627A	722112031023
	2627B			2627B	
Ball bearing	Version	Reference	Intermediate wheel	Version	Reference
	2627A	722112022040		2627A	722112031024
	2627B			2627B	
Oscillating weight bolt	Version	Reference	Minute wheel	Version	Reference
	2627A	722112022042		2627A	722262731041
	2627B			2627B	
Intermediate wheel	Version	Reference	Hour wheel, assembled	Version	Reference
	2627A	722112030012		2627A	7221120310463
	2627B			2627B	
Third wheel	Version	Reference	Cannon pinion with driving	Version	Reference
	2627A	722112030025		2627A	722262731083
	2627B			2627B	
Second wheel	Version	Reference	Setting wheel	Version	Reference
	2627A	722262730027		2627A	722112031100
	2627B	7222627B30027		2627B	
Additional second wheel	Version	Reference	Intermediate setting wheel	Version	Reference
	2627A	722262730030		2627A	722112031101
	2627B	7222627B30030		2627B	
Intermediate escape wheel	Version	Reference	Winding pinion	Version	Reference
	2627A	722262730039		2627A	722112031120
	2627B	7222627B30039		2627B	
Co-Axial wheel	Version	Reference	Sliding pinion	Version	Reference
	2627A	7222500B30040		2627A	7221120311211
	2627B	7222500C30040		2627B	
Ratchet wheel	Version	Reference	Reduction wheel	Version	Reference
	2627A	722112031020		2627A	722112032031
	2627B			2627B	

## Lists & Spare parts lists for Calibre 2627

Intermediate reduction wheel	Version	Reference	Setting lever jumper	Version	Reference
	2627A	722112032032		2627A	722112051091
	2627B			2627B	
Ratchet wheel driving wheel	Version	Reference	Click	Version	Reference
	2627A	722112032033		2627A	722112051120
	2627B			2627B	
Reversing wheel	Version	Reference	Reverser	Version	Reference
	2627A	722112032037		2627A	722112052040
	2627B			2627B	
Intermediate date wheel	Version	Reference	Auxiliary reverser	Version	Reference
	2627A	722262733011		2627A	722112052041
	2627B			2627B	
Date indicator driving wheel	Version	Reference	Date corrector operating lever	Version	Reference
	2627A	722112033020		2627A	722112053022
	2627B			2627B	
Differential	Version	Reference	Date jumper	Version	Reference
	2627A	722262736010		2627A	722262753080
	2627B			2627B	
Intermediate power reserve driving	Version	Reference	Stop lever	Version	Reference
	2627A	722262736055		2627A	722250056070
	2627B			2627B	7222500C56070
Intermediate differential driving	Version	Reference	Spring for power reserve differential	Version	Reference
	2627A	722262736057		2627A	722262766150
	2627B			2627B	
Pallet fork	Version	Reference	Jewelled shock-absorber, top	Version	Reference
	2627A	7222500B40010		2627A	722112070530
	2627B	7222500C40010		2627B	7222500C70530
Balance complete with stud	Version	Reference	Jewelled shock-absorber, bottom	Version	Reference
	2627A	7222500B4005021		2627A	722112070531
	2627B	7222500C4005021		2627B	7222500C70531
Stud support	Version	Reference	In settings, upper	Version	Reference
	2627A	7222500B40200		2627A	722112070640
	2627B			2627B	7222500C70640
Winding stem	Version	Reference	In settings, lower	Version	Reference
	2627A	72211205101021		2627A	722112070641
	2627B			2627B	7222500C70641
Yoke	Version	Reference	Cap jewels, upper	Version	Reference
	2627A	722112051050		2627A	722112070900
	2627B			2627B	
Setting lever, assembled	Version	Reference	Cap jewels, lower	Version	Reference
	2627A	72211205108006		2627A	722112070901
	2627B			2627B	

## Lists & Spare parts lists for Calibre 2627

Incabloc-spring, upper	Version	Reference	Screw for setting lever jumper	Version	Reference
	2627A	722112078004		2627A	72211203503
	2627B				
Incabloc-spring, lower	Version	Reference	Screw for balance bridge	Version	Reference
	2627A	722112078005		2627A	72211203503
	2627B				
Centre tube	Version	Reference	Screw for automatic device framework	Version	Reference
	2627A	722262780400		2627A	72211203503
	2627B				
Click plate	Version	Reference	Screw for automatic device lower bridge	Version	Reference
	2627A	722112081036		2627A	72211203504
	2627B				
Power reserve indicator wheel	Version	Reference	Screw for wheel train bridge	Version	Reference
	2627A	722262791420		2627A	72211203505
	2627B				
Date indicator for window aperture at 3 o'clock	Version	Reference	Screw for reverser maintaining plate	Version	Reference
	2627A	722262791440*		2627A	72211203506
	2627B	* Several versions available			
Screw for additional train wheel bridge	Version	Reference	Screw for ball bearing	Version	Reference
	2627A	72226271005001		2627A	72211203507
	2627B				
Screw for escape wheel bridge	Version	Reference	Screw for click plate	Version	Reference
	2627A	72226271005501		2627A	72211203509
	2627B				
Screw for date jumper maintaining plate	Version	Reference	Screw for casing clamp	Version	Reference
	2627A	72226271311101		2627A	72211203510
	2627B				
Screw for power reserve indicator bridge	Version	Reference	Screw for pallet bridge	Version	Reference
	2627A	72226271602601		2627A	72225003511
	2627B	7222627B1602601			
Screw for spring for power reserve differential	Version	Reference	Screw for stud	Version	Reference
	2627A	72226276615001		2627A	72225003512
	2627B				
Screw for barrel bridge	Version	Reference			
	2627A	72211203503			
	2627B				

Fig. 1.0

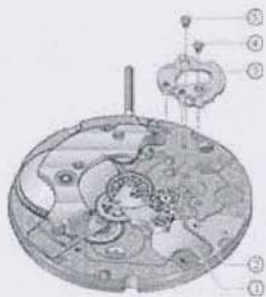

## 1.0 Assembling of the escapement system

### Key points

The order of assembly must be respected.

After assembling, the escapement functions must be checked accurately with the corresponding tool.

The pallet bridge positions the co-axial wheel and the pallet fork. To ensure the functioning of the escapement it is necessary to respect the following order of assembly:

1. Position the co-axial wheel.
2. Position the pallet fork.
3. Position the pallet bridge, screw no (4) must be correctly placed in their beds.
4. To position the pallet bridge, screw no (4) must be fixed first.
5. The second screw (5) fixes the bridge.

Fig. 2.0

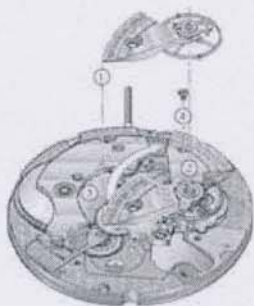

## 2.0 Assembling of the balance bridge

As the table roller is under the pallet fork, the balance must be assembled carefully.

1. Position the complete balance bridge (with balance). The bridge is pointing towards the center of the movement.
2. Check the position of the balance. The pivot of the balance-staff must be correctly placed in its bed.
3. Carefully turn the bridge to its normal position.
4. Fix the bridge with its screw.

Fig. 2.1

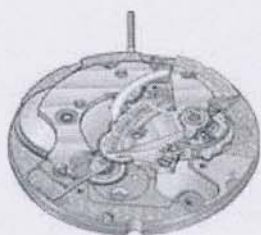

## 2.1 Disassembling of the balance bridge

The balance bridge must be disassembled by removing the parts in the opposite order of procedure 3.3. To avoid any risk of damaging the balance, the bridge has to be turned towards the center of the movement. In this position the bridge may be removed without any risk.



3.0 Function of Power reserve

Winding-up

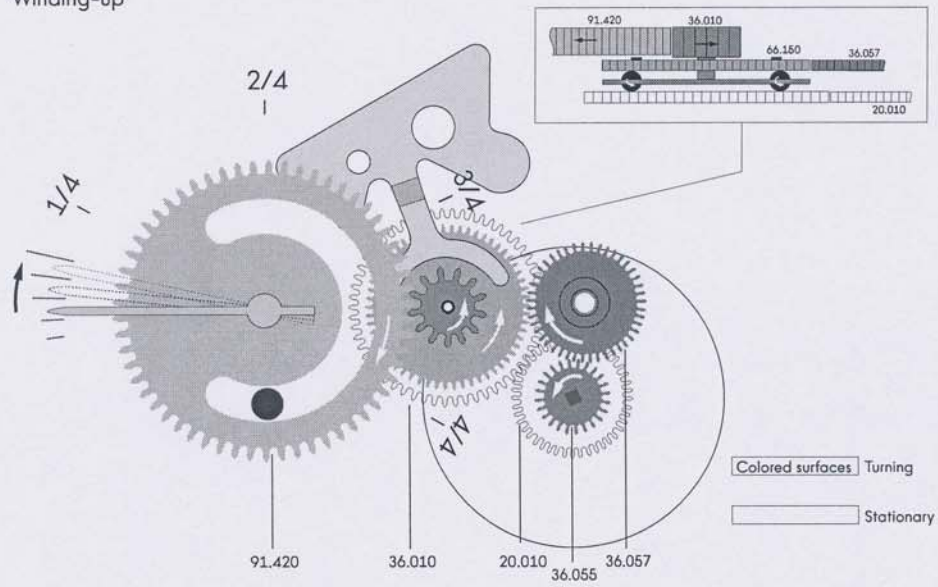

Unwinding

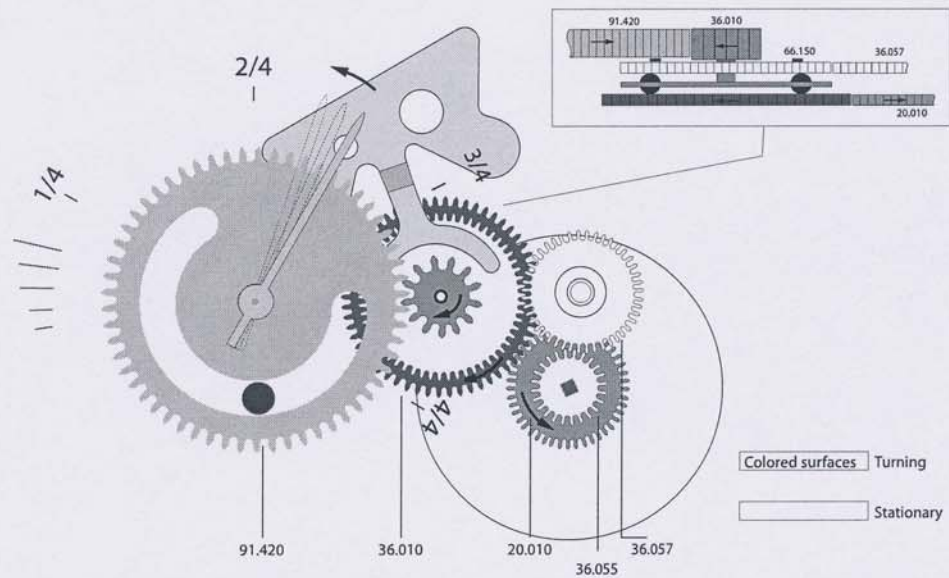

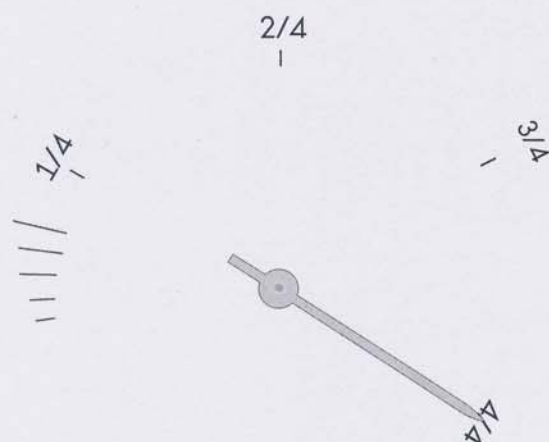

#### 4.0 Setting of Power Reserve hand











1. After dial setting:  
Wind up the movement completely and pull winding stem in position 3.
2. Fit the Power Reserve hand slightly on the 4/4 mark as shown below.
3. Wind the movement a few turns. The hand must remain on the 4/4 mark. If not, it has to be repositioned.
4. Fit the hand correctly.

#### 4.1 Runners for hand setting and hand setting force

Désignation	Porte-pièces pour pose aiguilles	No de broches pour pose aiguilles	Force minimum (N)	Force maximum (N)	Appui (pivot)
Aiguille des Heures	507 0017 winding stem in position B	5	10	55	non
Aiguille des Minutes		1	10	55	non
Aiguille des Secondes		1	10	20	non
Aiguille réserve de marche		1	10	20	non

## 5.0 Epilame

### 5.1 Components not to be coated with epilame after cleaning

Designation	Reference	
Balance assembled on balance bridge *	40055 + 10058°	
Balance complete	40055	
Pallet fork Co-Axial	40010	
In settings, upper *	70640	
In settings lower *	70641	
Pallet bridge	1005707	
Complete barrel**	20010	
Mainspring	20102	
Reversing wheel	32037	 

\* Do not treat the shock-absorber settings with epilame; the cap jewels should however be treated

\*\* Do not treat the complete barrel with epilame, only the drum, cover and arbour separately

## Specific informations for Calibre 2627

Demagnetise the movement according to Working Instruction 34.

### Values to be checked

Please consult Working Instructions 5 and 28 for instructions and tolerances.

### Measure particularities according to instrument type used.

Instrument type	Measure on Co-Axial 4 Hz version	Measure on Co-Axial 3.5 Hz version	Comments
<b>Old Witschi measuring instrument</b> - Watch Expert (red case) - Wicometer Professionnal - Chronoscope M1 (old version)	Lift angle to be set at 30°	Lift angle to be set at 38°	<b>Version 3.5 Hz:</b> The frequency (25'200 A/h), has to be set manually in order to have the rate correctly indicated.
	All measures good	Amplitude not correctly measured	
<b>New Witschi measuring instrument</b> - Watch Expert II (white case) - Chronoscope M1 (updated version)	Lift angle to be set at 38°	Lift angle to be set at 38°	<b>Test mode:</b> «Spe1» must be set!
	All measures good	All measures good	

Fig. 6.0

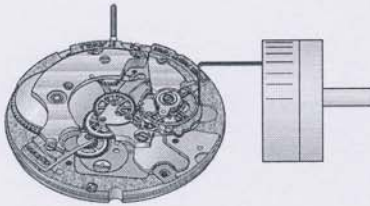

### 6.0 Timing key

A special timing key tool (see fig. 6.1) has been developed to adjust the rate even when the movement is cased in. The rate can be corrected according to the table below by turning the two balance screws a complete turn. A scale is found on the outside of the tool. A division corresponds to a rate correction of 1 second. (according to the table below).

One screw is located between two arms on the balance which are specially marked by points (see Figure 6.2) for easy identification of each screw during the correction process.

Fig. 6.1

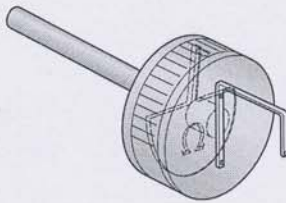

### Balance

The annular balance has two adjusting micro-screws. A slow rate deviation is corrected by tightening the micro-screws (towards the centre of the balance), which reduces its moment of inertia and makes it run faster. A fast rate deviation is corrected by loosening the micro-screws (away from the centre of the balance). This increases its moment of inertia and makes it run slower.

Fig. 6.2

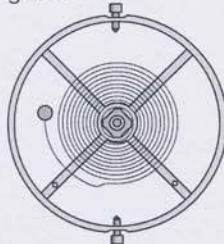

REF. 502 200 0501

### Important:

The rate is always corrected using **both adjustment screws** to prevent an unbalance of the balance.

Version A	Version B
One correction turn = 52 seconds	One correction turn = 86 seconds
One division = 1 second	One division = 1.5 seconds

## Modifications of Technical Guide for Calibre 2627

Technical Guide versions				
Date of first edition:	22.09.2005	Version A	Made by:	Pelrom
Date of second edition:	21.06.2007	Version B		
Date of third edition:	06.12.2007	Version C		
Date of last edition:	29.12.2008	Version D		Rendav

Modifications of Technical Guide version B	
Old (version A)	New (version B)
	<b>Adds of tools and references:</b>  Key cam for rotor            502 200 0361 Support for rotor            502 100 0381 Mainspring                    7222500C20102 Barrel complete              7222627B20100

Modifications of Technical Guide version C	
Old (version B)	New (version C)
	<b>Adds:</b>  - Stop lever (Differences between version A&B) - Runners for hand setting and hand setting force  All the modifications are mentionned in red.

Modifications of Technical Guide version D	
Old (version C)	New (version C)
	All the information's that are mentioned in red have been modified or updated.