

ETA 2681

TECHNICAL
COMMUNICATION

COMUNICACIÓN
TÉCNICA

COMUNICAZIONE
TECNICA

8³/₄'''

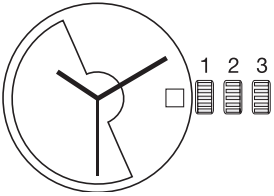
<p>8³/₄''' Ø 19,40 mm</p>	
<p>Movement height Altura de máquina Altezza movimento</p>	<p>4,80 mm</p>
<p>Running time / Reserva de marcha / Riserva di marcia</p>	<p>38 h</p>
<p>Number of jewels / Número de piedras / Numero di pietre</p>	<p>25</p>
<p>Frequency / Frecuencia / Frequenza</p>	<p>28'800 A/h</p>
<p>Angle of lift of balance / Ángulo de alzamiento / Angolo di alzamento</p>	<p>51°</p>

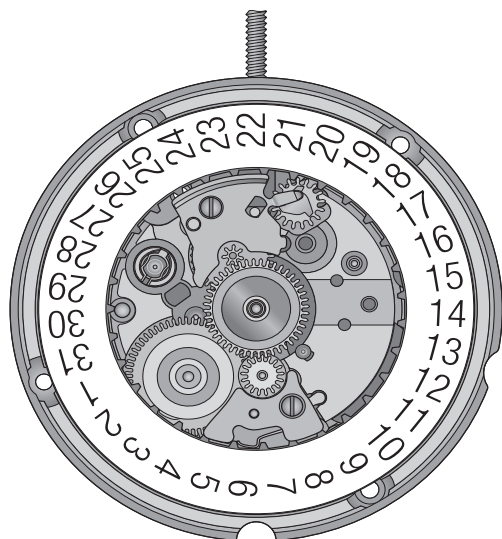
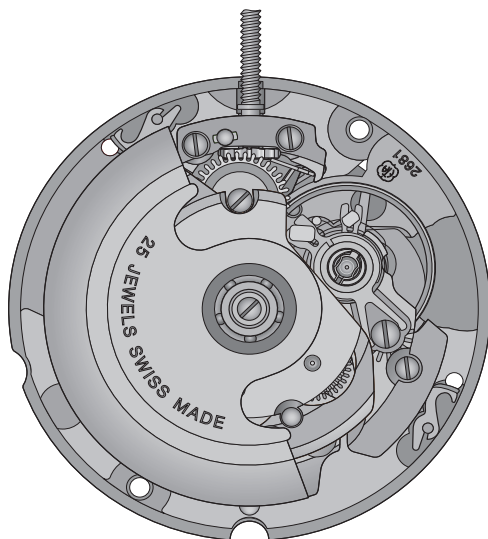

ETA SA
MANUFACTURE HORLOGÈRE SUISSE
DEPUIS 1793

Interchangeability - Intercambiabilidad - Intercambiabilità

No No No	No No CS No	LIST OF MATERIALS	LISTA DE FORNITURAS	ELENCO DELLE FORNITURE	Cal. Cal. Cal.
100	10.020.07	Main plate, jewelled	Platina, empedrada	Piastra, con pietre	2681
105	10.041.07	Barrel bridge, jewelled	Puente de cubo, empedrado	Ponte del bariletto, con pietre	2681
110	10.048.07	Train wheel bridge, jewelled	Puente de rodaje, empedrado	Ponte del ruotismo, con pietre	2650
121/4	10.058.24	Balance bridge, for regulator with pointer, shock-absorber, stud support and corrector	Puente de volante, para raqueta con flecha, para amortiguador, porta-pitón y corrector.	Ponte del bilanciere, per racchetta, con freccia, ammortizzatore, portapitone e correctore	2650
125	10.057.07	Pallet bridge, jewelled	Puente de áncora, empedrado	Ponte dell'ancora con pietre	2640
144	10.300.00	Dial fastener	Sujetador de cuadrante	Ferma-quadrante	2640
161	80.400.00	Centre tube	Tubito de centro	Tubo di centro	2640
180/1	20.010.00	Movement barrel, complete	Cubo completo de máquina	Bariletto completo del movimento	2650
182	20.030.00	Barrel (drum and cover)	Cubo (tambor y tapa)	Bariletto (tamburo e coperchio)	2650
195	20.060.00	Barrel arbor	Árbol de cubo	Albero del bariletto	2640
203	30.012.00	Intermediate wheel	Rueda intermedia	Ruota intermedia	2640
210	30.025.00	Third wheel	Rueda primera	Ruota mediana	2640
227	30.027.00	Minute wheel	Rueda de segundos	Ruota dei secondi	2660
242	31.083.00	Cannon pinion with driving wheel	Cañón de minutos con arrastrador	Pignone calzante con conduttore	2640
255/1	31.046.06	Hour wheel, assembled	Rueda de horas, ajustada	Ruota delle ore, montata	2640
260	31.041.00	Minute wheel	Rueda de minutería	Ruota della minuteria	2640
303/5	40.302.23	Two-piece regulator, with pointer, for stud support ETACHRON and corrector	Raqueta de 2 piezas, con flecha, para porta-pitón ETACHRON y corrector	Racchetta in 2 pezzi, con freccia, per portapitone ETACHRON e correttore	2660
358	40.380.00	Regulator corrector	Corrector de raqueta	Correttore della racchetta	2660
375	40.200.00	Stud support, ETACHRON	Porta-pitón, ETACHRON	Portapitone, ETACHRON	2660
401/3	51.012.21	Winding stem with helical square, thread diameter 0,90 mm	Tija de remontuar de cuadrado helicoidal, diámetro de fileteado 0,90 mm	Albero di carica con quadro elicoidale, diametro di filettatura 0,90 mm	2641
407	31.121.00	Sliding pinion	Piñón corredizo	Pignone scorrevole	2641
410	31.120.00	Winding pinion	Piñón de remontuar	Pignone di carica	2640
415	31.020.00	Ratchet wheel	Rochete	Rocchetto	2650
420	31.023.00	Crown wheel	Rueda de corona	Ruota a corona	2650
434	51.120.00	Spring-click	Muelle trinquete	Molla cricco	2650
435	51.050.00	Yoke	Báscula de piñón corredizo	Bascula del pignone scorrevole	2640
443/1	51.080.06	Setting lever, assembled	Tirette, ajustado	Tiretto, montato	2640
440	61.100.00	Yoke spring	Muelle de báscula	Molla della bascula	2640
445	51.090.00	Setting lever jumper	Muelle flexible de tirete	Scatto del tiretto	2641
450	31.100.00	Setting wheel	Rueda de transmisión	Rinvio	2640
462	10.062.00	Minute train bridge	Puente del rodaje de minutería	Ponte del ruotismo di minuteria	2641
705	30.040.00	Escape wheel	Rueda de escape	Ruota di scappamento	2660
710	40.010.00	Pallet fork	Áncora	Ancora	2660
714	40.020.00	Pallet staff	Tija de áncora	Albero dell'ancora	2660
721	40.050.21	Timed annular balance, for shock-absorber and stud support ETACHRON	Volante anular, regulado, para amortiguador y porta-pitón ETACHRON	Bilanciere regolato, per ammortizzatore e portapitone ETACHRON	2660
728	40.100.21	Balance staff, for shock-absorber and annular balance	Eje de volante, para amortiguador	Albero del bilanciere, per ammortizzatore	2640
730	40.120.00	Double roller	Platillo doble	Doppio-disco	2640
771	20.102.00	Mainspring with sliding attachment	Muelle motor con muelle de frenar	Molla-motrice con molla di freno	2670
1134	12.030.00	Automatic device framework	Marco del dispositivo automático	Gabbia del dispositivo automatico	2650
1141	12.051.07	Automatic device lower bridge, jewelled	Puente inferior del dispositivo automático, empedrado	Ponte inferiore del dispositivo automatico, con pietre	2650
1143/1	22.010.06	Oscillating weight, assembled	Masa oscilante, ajustada	Massa oscillante, montata	2681
1481	32.301.00	Reduction wheel	Rueda de reducción	Ruota di riduzione	2650
1482	32.033.00	Ratchet wheel driving wheel	Rueda de arrastre de rochete	Ruota conduttrice del rocchetto	2650
1488	32.037.00	Reversing wheel	Rueda de inversión	Ruota d'inversione	2650
1497	22.040.00	Ball bearing	Rodamiento de bolillas	Cuscinetto a sfere	2650
1530	32.038.00	Auxiliary reversing wheel	Rueda auxiliar de inversión	Ruota ausiliaria d'inversione	2650











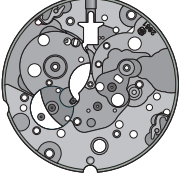





































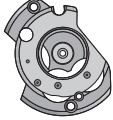







Interchangeability - Intercambiabilidad - Intercambiabilità

No No No	No No CS No		LIST OF MATERIALS	LISTA DE FORNITURAS	ELENCO DELLE FORNITURE	Cal. Cal. Cal.
2535	13.105.00		Date indicator maintaining plate	Placa de sujeción del indicador de fecha	Placca di guardia dell'indicatore del datario	2641
2539	53.022.00		Date corrector operating lever	Mando del corrector de fecha	Comando del correttore della data	2641
2543	33.011.00		Intermediate date wheel	Rueda intermedia de fecha	Ruota intermedia del datario	2641
2556	33.020.00		Date indicator driving wheel	Rueda de arrastre del indicador de fecha	Ruota conduttrice dell'indicatore della data	2641
2557/1	91.440.22		Date indicator, for window opening at 3 o'clock	Indicador de fecha, para abertura de ventanilla en 3h	Indicatore della data, per apertura a sportellino alle 3 ore	956.411
2566	53.200.00		Date corrector	Corrector de fecha	Correttore della data	2641
2576	53.080.00		Date jumper	Muelle flexible de fecha	Scatta-data	2641
3024	70.500.00		Jewelled shock-absorber for balance, shouldered, to press in, top	Amortiguador, empedrado, de volante, de embutir, de asiento, encima	Ammortizzatore, con pietra, del bilanciere, a pressione, con piano di appoggio, sopra	2640
3025	70.501.00		Jewelled shock-absorber for balance, shouldered, to press in, bottom	Amortiguador empedrado, de volante, de embutir, de asiento, debajo	Ammortizzatore, con pietra, del bilanciere, a pressione, con piano di appoggio, sotto	2640
9433	56.070.00		Stop lever	Palanquita-stop	Leva stop	2640
5101	10.020.01	2x	Case screw	Tornillo de fijación	Vite di fissaggio	2657
5102	10.020.02	2x	Case screw, special	Tornillo de fijación, especial	Vite di fissaggio, speciale	2657
1) 5105	10.041.01	3x	Screw for barrel bridge	Tornillo del puente de cubo	Vite del ponte del bariletto	2640
1) 5110	10.048.01	2x	Screw for train wheel bridge	Tornillo del puente de rodaje	Vite del ponte del ruotismo	2640
1) 5121	10.058.01	1x	Screw for balance bridge	Tornillo del puente de volante	Vite del ponte del bilanciere	2640
1) 5125	10.057.01	1x	Screw for pallet bridge	Tornillo del puente de ánclora	Vite del ponte d'ancora	2640
5415	31.020.01	1x	Screw for ratchet wheel	Tornillo del rochete	Vite per il rocchetto	2640
5420	31.023.01	1x	Screw for crown wheel, lefthanded thread	Tornillo de la rueda de corona	Vite per la ruota a corona	2650
1) 5445	51.090.01	1x	Screw for setting lever jumper	Tornillo del muelle flexible de tirete	Vite dello scatto del tiretto	2640
1) 5462	10.062.01	1x	Screw for minute train bridge	Tornillo del puente de rodaje de minutería	Vite del ponte del ruotismo di minutería	2640
51134	12.030.01	2x	Screw for automatic device framework	Tornillo del marco del dispositivo automático	Vite della gabbia del dispositivo automatico	2650
51141	12.051.01	1x	Screw for automatic device lower bridge	Tornillo del puente inferior del dispositivo automático	Vite del ponte inferiore del dispositivo automatico	2650
51497	22.040.01	1x	Screw for ball bearing	Tornillo del rodamiento de bolillas	Vite del cuscinetto a sfere	2650
1) 52535	13.105.01	1x	Screw for date indicator maintaining plate	Tornillo de la placa de sujeción del indicador de fecha	Vite della placca di guardia dell'indicatore del datario	2641
			Identical screws	1) 5105		
			Tornillos idénticos	5110		
			Vite identiche	5121		
				5125		
				5445		
				5462		
				52535		

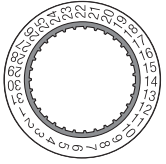
Screws Tornillos Vite	M _L Minimum torque for loosening M _L Par mínimo para desatornillar M _L Coppia minima per svitare
5101 5102	1,0 Ncm

Materials - Fornituras - Forniture

2681

								5101
100	105	110	121/4	125	144	161		
								5102
180/1	182	195	203	210	227	242	255/1	
								5105 5110 5121 5125 5445 5462 52535
260	303/5	358	375	401/3	407	410	415	420
								
434	435	440	443/1	445	450	462	705	
								5415
710	714	721	728	730	771	1134	1141	5420
								51134
1143/1	1481	1482	1488	1497	1530	2535	2539	
								51141
2543	2556	2557/1	2566	2576	3024	3025	9433	51497

Assembling of the handsetting and the date mechanisms

(Parts listed in order of assembly)

Montaje del mecanismo de puesta en hora y de fecha

(Lista de fornitureas por orden de ensamblado)

Montaggio del meccanismo della messa all'ora e della data

(Elenco delle forniture in ordine di montaggio)

100	450
407	2556
410	2543
401/3	255/1
443/1	2566
2539	2557/1
435	462
440	5462 (1x)
445	2576
5445 (1x)	2535
242	52535 (1x)
260	

M_L Minimum torque for loosening



M_L Par mínimo para desatornillar

M_L Coppia minima per svitare

(b) 0,7 Ncm

	Lubricate part 2576. 1. Lubrique la pieza 2576. Lubrificare il pezzo 2576.
	Rotate part 2557/1 approx 10 teeth with rapide correction. 2. Gire la pieza 2557/1 unos 10 dientes con la corrección rápida. Ruotare il pezzo 2557/1 di circa 10 denti con la correzione rapida.
	Lubricate again part 2576. 3. Lubrique de nuevo la pieza 2576. Lubrificare di nuovo il pezzo 2576.
	Rotate part 2557/1 approx 10 teeth with rapide correction again. 4. Gire de nuevo la pieza 2557/1 unos 10 dientes con la corrección rápida. Ruotare di nuovo il pezzo 2557/1 di circa 10 denti con la correzione rapida.

Lubrication – Lubricación – Lubrificazione

	Thick oil or grease Aceite espeso de viscosidad elevada o grasa Olio denso a viscosità elevata o grass	Moebius D5 or / ó / o HP 1300
	Grease Grasa Grasso	Moebius 9501 or / ó / o Jismaa 124

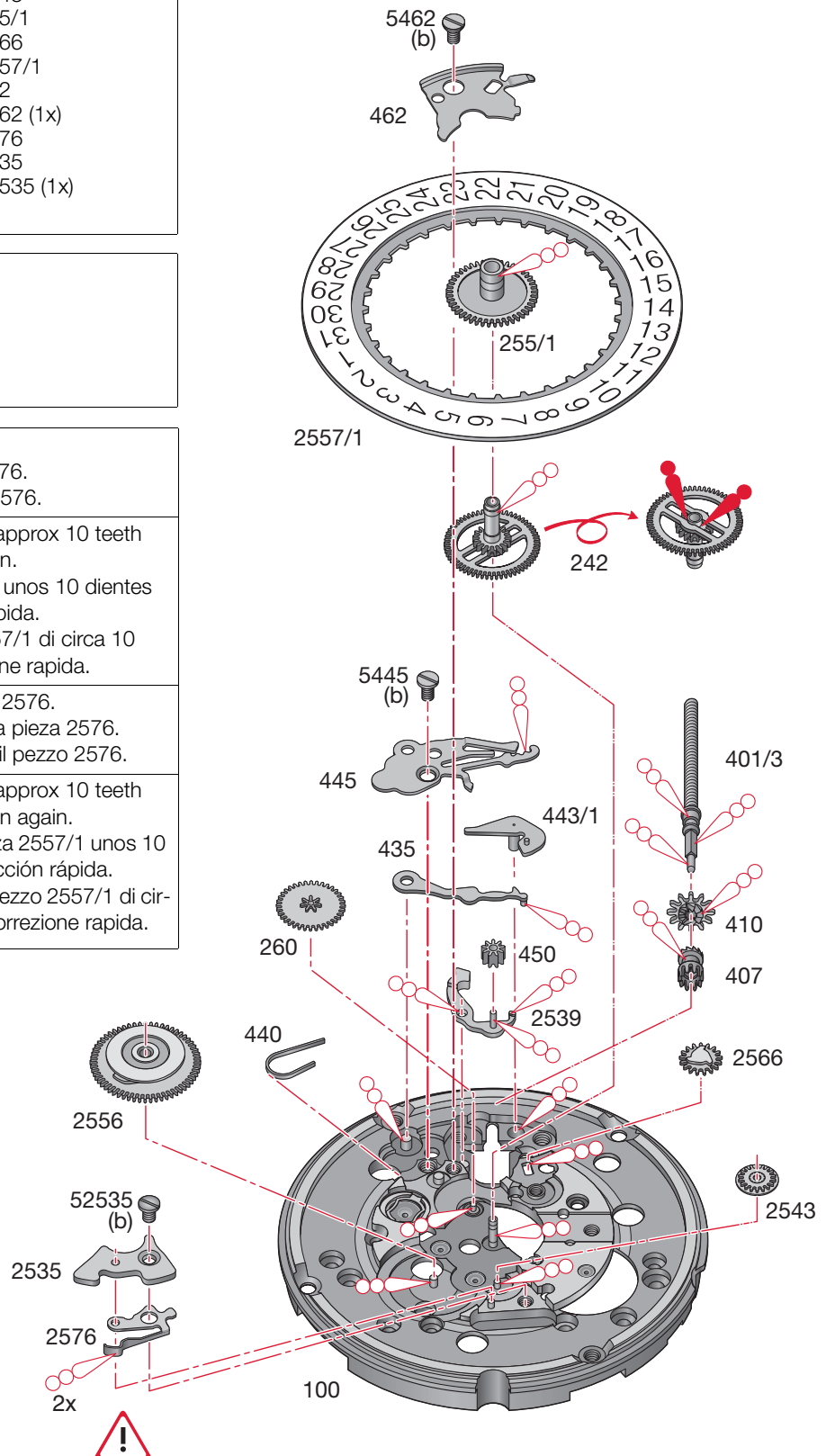

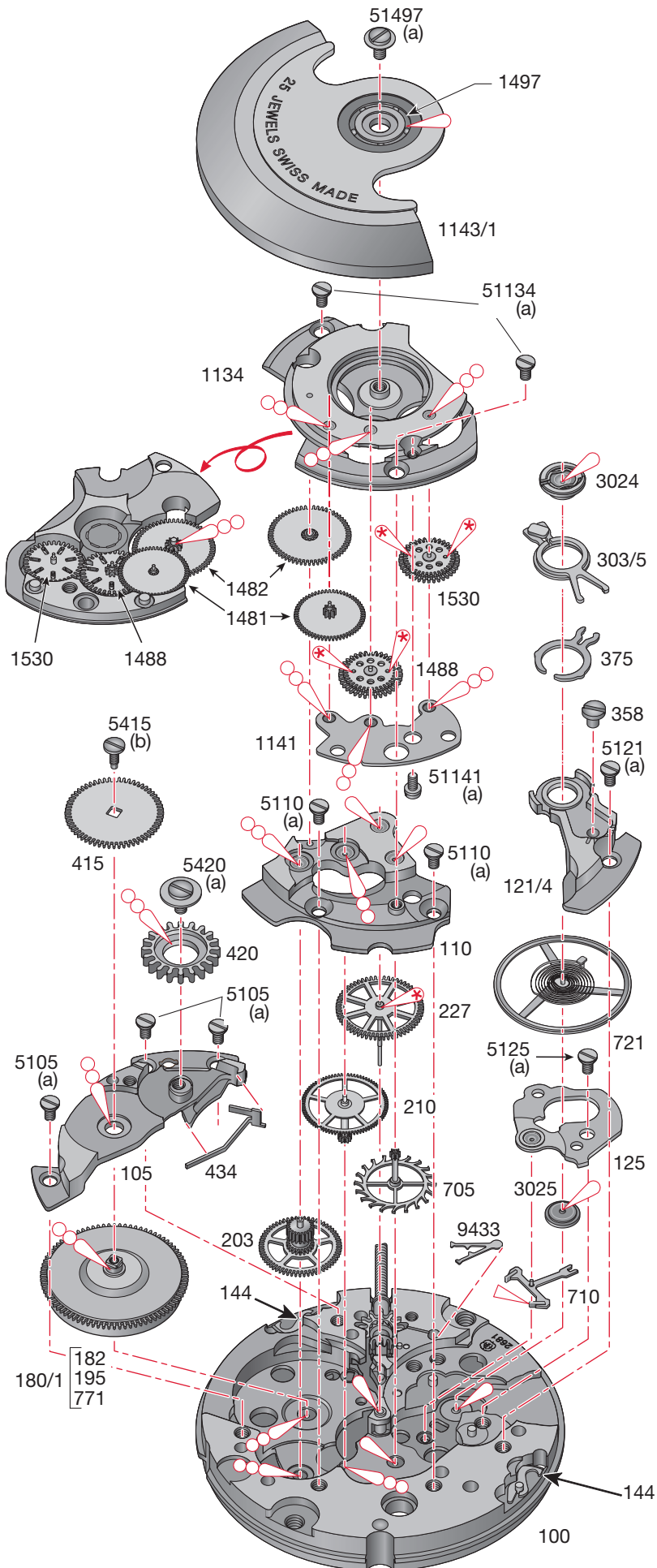

Assembling of the basic movement and the self-winding mechanism

(Parts listed in order of assembly)

Montaje de la máquina de base y del mecanismo automático

(Lista de fornitureas por orden de assemblado)

Montaggio del movimento di base e del meccanismo automatico

(Elenco delle forniture in ordine di montaggio)

3025	5420 (1x)
203	434
705	303/5 375 3024 358 721
210	
227	
110	
5110 (2x)	
710	5121 (1x)
125	1134
5125 (1x)	1482
180/1	1530
	1488
	1481
9433	1141
105	51141 (1x)
5105 (3x)	51134 (2x)
415	1143/1
5415 (1x)	51497 (1x)
420	

Lubrication – Schmierung – Lubrication

Fine oil	Moebius 9010
Aceite fino	
Olio fluido	
Very small quantity	Moebius 9010
Cantidad muy pequeña	
Piccolissima quantità	
Thick pressure-resistant oil or grease	Moebius D5
Aceite espeso de viscosidad elevada o grasa	or / ó / o
Olio denso a viscosità elevata o grasso	HP 1300
Special oil for pallet stones	Moebius 941
Aceite especial para escape	or / ó / o
Olio speciale per scappamento	Moebius 9415

M_L Minimum torque for loosening

M_L Par mínimo para desatornillar

M_L Coppia minima per svitare

(a)	0,6	Ncm
(b)	0,7	Ncm

We reserve all rights for this document. It is meant for the recipient only and it may not be copied, printed or given to a third person without our written permission.

Quedan reservados todos los derechos relacionados con este documento, que está dirigido únicamente al destinatario. Queda por lo tanto prohibida su copia, impresión o cesión a terceros sin nuestra autorización por escrito.

Ogni diritto su questo documento è riservato. Il documento è indirizzato esclusivamente al destinatario e non può essere copiato, stampato o ceduto a terzi senza un'autorizzazione scritta.

Ajustement aiguille des heures
Stundenzeigerpassung
Hour hand fitting

Ajustement aiguille des minutes
Minutenzeigerpassung
Minute hand fitting

Ajustement aiguille des secondes
Sekundenzeigerpassung
Second hand fitting

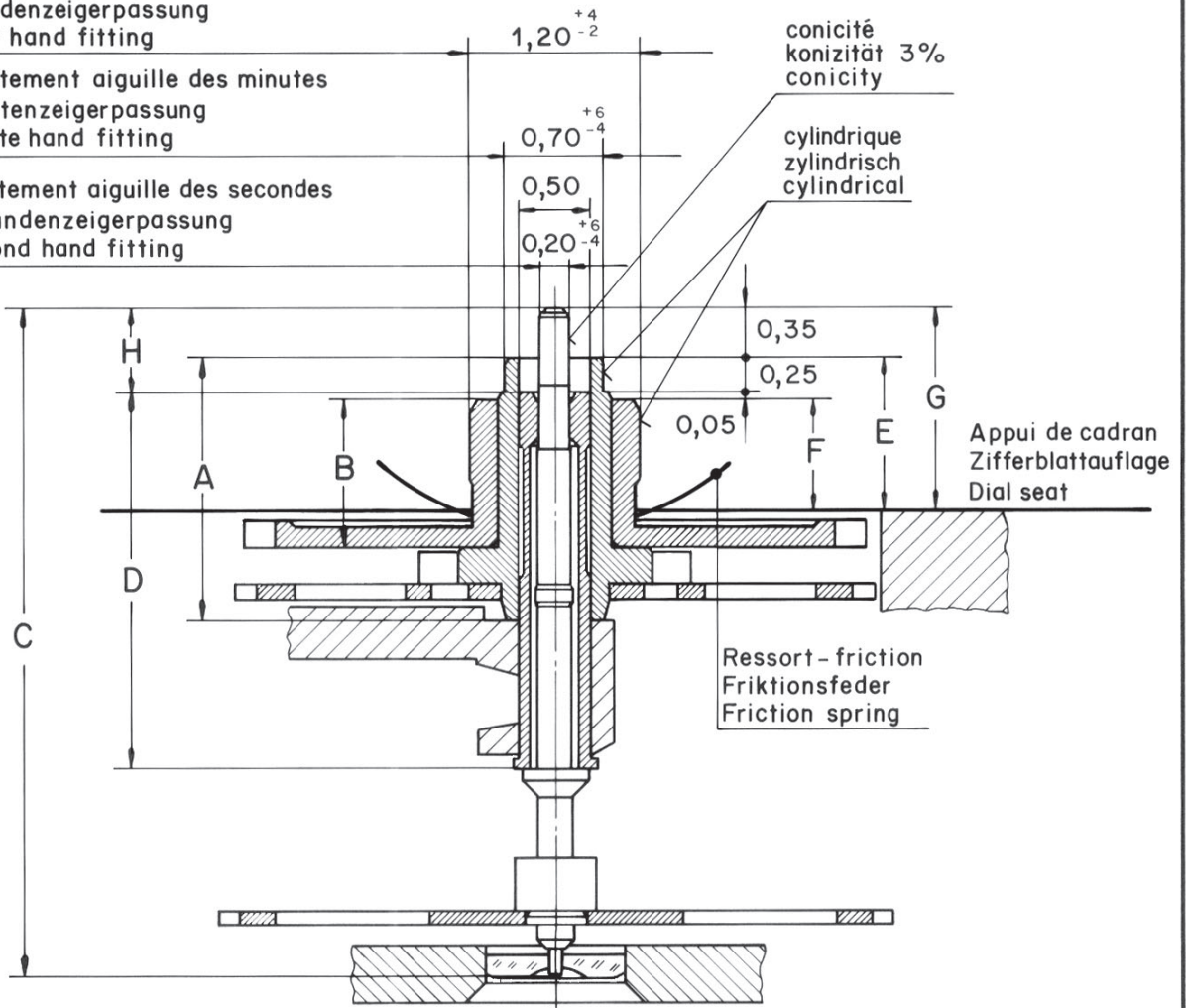

Aiguillage Zeigerwerk- höhe Hand fitting height	Longueur/Länge/Length				Dépassement Höhe über Zifferblattauflage Height over dial seat			H
	A	B	C	D	E	F	G	
	Chaussée Minutenrohr Cannon-pinion	Roue des heures Stundenrad Hour wheel	Pignon des secondes Sekundentrieb Second wheel pinion	Tube de centre Zentrumrohr Centre tube	Chaussée Minutenrohr Cannon-pinion	Roue des heures Stundenrad Hour wheel	Pignon des secondes Sekundentrieb Second wheel pinion	
1	1,88	1,06	4,77	2,68	1,10	0,80	1,45	0,60
2	2,13	1,31	5,02	2,68	1,35	1,05	1,70	0,85

Aiguillages
Zeigerwerkhöhen
Hand fitting heights

Cal. 2681/2691

Anderungen:
Modifications:



ETA
Groupe de Fabriques d'Ebauches
CH - 2540 Grenchen

Masse in mm Tol. in 1/1000 mm
Dim. en mm Tol. en 1/1000 mm
Dim. in mm Tol. in 1/1000 mm

Massstab:
Echelle:
Scale:

Datum:
Date: 23. 11. 88



Gezeichnet:
Dessiné: hm
Drawn:

Kontrolliert:
Contrôlé: 2f
Checked:

*Modifications compared with
previous document versions*

*Modificaciones comparadas con
las versiones anteriores del docu-
mento*

*Modifiche comparate con le versio-
ni precedenti del documento*

Version Versión Version	Date Fecha Data	Modification	Modificación	Modifica	Page Página Pagina
04	28.11.07	Reduction wheel (Pos. 1481).	Rueda de reducción (Pos. 1481).	Ruota di riduzione (Pos. 1481).	6
		Lubrication (Pos. 2557/1, 2576).	Lubrificación (Pos. 2557/1, 2576).	Lubrificazione (Pos. 2557/1, 2576).	5
		Minimum torque for loosening.	Par mínimo para desatornillar.	Coppia minima per svitare.	3, 5, 6
		New logos.	Nuevas logos.	Nuovi logos.	1, 8
03	06.03.06	Lubrication Moebius HP1300.	Lubrificación Moebius HP1300.	Lubrificazione Moebius HP1300.	5, 6
02	28.10.05	Basic version.	Versión de base.	Versione di base.	--



ETA^{SA}
MANUFACTURE HORLOGÈRE SUISSE
DEPUIS 1793

CUSTOMER SERVICE

Bahnhofstrasse 9
P.O. Box 359
2540 Grenchen
Schweiz

Tel +41 (0)32 655 27 77
Fax +41 (0)32 655 84 30

etacs@eta.ch
www.eta.ch