

CALIBRE – KALIBER – CALIBRE 861A

<p style="text-align: center; font-size: 2em; font-weight: bold;">12'''</p> <p style="text-align: center;">ø 27 mm</p> <p>Hauteur mouvement Werkhöhe Movement height</p> <p style="text-align: right; margin-right: 50px;">6,87 mm</p>											
<table style="width: 100%; border: none;"> <tr> <td style="border: none;">Réserve de marche / Gangreserve / Power reserve</td> <td style="text-align: right; border: none;">45 h</td> </tr> <tr> <td style="border: none;">Nombre de rubis / Anzahl Rubine / Number of jewels</td> <td style="text-align: right; border: none;">18</td> </tr> <tr> <td style="border: none;">Fréquence / Frequenz / Frequency</td> <td style="text-align: right; border: none;">3 Hz (21'600 A/h)</td> </tr> <tr> <td style="border: none;">Angle de levée / Hebungswinkel der Unruh / Angle of lift</td> <td style="text-align: right; border: none;">50°</td> </tr> <tr> <td style="border: none;">Tige de remontoir / Aufzugwelle / Winding stem</td> <td style="text-align: right; border: none;">ø 1,00 mm</td> </tr> </table>		Réserve de marche / Gangreserve / Power reserve	45 h	Nombre de rubis / Anzahl Rubine / Number of jewels	18	Fréquence / Frequenz / Frequency	3 Hz (21'600 A/h)	Angle de levée / Hebungswinkel der Unruh / Angle of lift	50°	Tige de remontoir / Aufzugwelle / Winding stem	ø 1,00 mm
Réserve de marche / Gangreserve / Power reserve	45 h										
Nombre de rubis / Anzahl Rubine / Number of jewels	18										
Fréquence / Frequenz / Frequency	3 Hz (21'600 A/h)										
Angle de levée / Hebungswinkel der Unruh / Angle of lift	50°										
Tige de remontoir / Aufzugwelle / Winding stem	ø 1,00 mm										

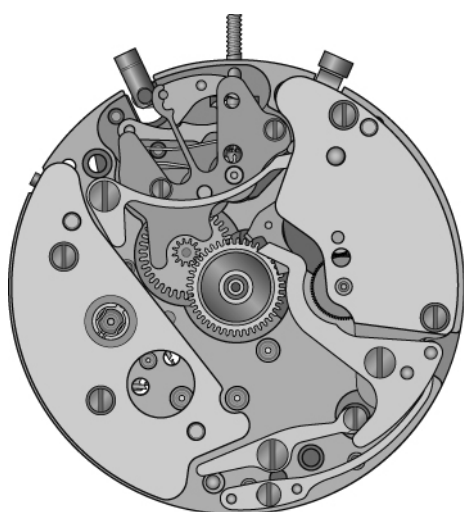

Informations générales

Démontage

Attention:

- Lors du démontage, enlever les ressorts délicatement pour ne pas fausser l'armage de ceux-ci.
- Ne pas tourner les excentriques encadrés en rouge: 1701, 1702 (page 5) et l'excentrique monté sur 1779 (page 6).
- Enlever la bascule compteur d'heures 1774 pour pouvoir désarmer le ressort de barillet.
- Procéder au démontage complet.

Nettoyage:

- Selon procédé habituel.

Contrôler:

- L'état du revêtement TEFLON sur le ressort-friction du mobile de chronographe 1735.

Assemblage

L'assemblage est divisé en quatre parties:

1. Mécanisme de mise à l'heure
Voir page 3
2. Mouvement de base et échappement
Voir page 4
3. Mécanisme de chronographe
Voir page 5
4. Compteur d'heures, chaussée et roue des heures
Voir page 6

L'ordre d'assemblage est indiqué sur chaque page selon les numéros des fournitures dans l'ordre d'assemblage.

Les contrôles à effectuer pendant l'assemblage sont indiqués par les signes **CONTR. 1** à **CONTR. 5**. Veuillez vous référer au texte page 7.

Posage d'aiguilles

Au posage des aiguilles de petite seconde et des compteurs, il est important de tenir compte des différentes grandeurs entre les tubes.

Outillage

Porte-mouvement (bague)	502.110.0181
Porte-mouvement à poussoirs	502.110.0182
Estrapade	502.150.0007

Allgemeine Informationen

Zerlegen

Vorsicht:

- Beim Entfernen der Federn ist darauf zu achten, das deren Spannkraft nicht verändert wird.
- Die rot umrandeten Exzenter: 1701, 1702 (Seite 5) und den Exzenter auf 1779 (Seite 6) nicht verstellen.
- Die Stundenzählradwippe 1774 entfernen, damit die Zugfeder entspannt werden kann.
- Das Uhrwerk komplett zerlegen.

Reinigen:

- Auf herkömmliche Art.

Kontrollieren:

- Den Zustand der Teflonaufgabe der Friktionsfeder für Chrono-Zentrumrad 1735.

Zusammenbau

Der Zusammenbau ist in vier Etappen unterteilt:

1. Zeigerstellmechanismus
Siehe Seite 3
2. Basiswerk mit Hemmung
Siehe Seite 4
3. Chronograph-Mechanismus
Siehe Seite 5
4. Stundenzähler, Minutenrohr und Stundenrad
Siehe Seite 6

Die Reihenfolge des Zusammenbaus ist auf diesen Seiten durch die Ersatzteilnummern in Montager Reihenfolge angegeben.

Während des Zusammenbaus sind gewisse Kontrollen auszuführen. Diese sind angezeigt durch die Zeichen **CONTR. 1** bis **CONTR. 5**. Siehe Text Seite 7.

Zeiger setzen

Beim setzen der Zeiger von kleiner Sekunde und Chronographenzähler ist es wichtig die verschiedenen Tubusgrößen zu beachten.

Werkzeug

Werkhalterrings	502.110.0181
Werkhalter mit Drücker	502.110.0182
Federwinder	502.150.0007

General information

Dismantling

Caution:

- When removing the different springs, do not bend them in order not to modify their tension.
- Do not turn the eccentrics (in red frames) 1701, 1702 (page 5) and the eccentric mounted on 1779 (page 6).
- Remove the hour recorder yoke 1774, so you can disarm the mainspring.
- Proceed with the complete dismantling.

Cleaning:

- In the usual manner.

Check:

- The state of the TEFLON coating on the friction-spring of the chronograph runner 1735.

Assembly

The assembly is divided into four parts:

1. Handsetting mechanism
See page 3
2. Basic movement and escapement
See page 4
3. Chronograph-mechanism
See page 5
4. Hour counter, cannon pinion and hour wheel
See page 6

The order of assembly is indicated on these pages by the spare parts numbers in order of assembly.

During assembly, some controls have to be effectuated. They are indicated by the signs **CONTR. 1** to **CONTR. 5**. Refer to the text on page 7.

Hand setting

When setting the small second and the counter hands, it is important to pay special attention to the different tube sizes of the hands.



Tool

Movement holder (ring)	502.110.0181
Movement holder with pushers	502.110.0182
Mainspring winder	502.150.0007

1. Liste de fournitures par ordre d'assemblage
Bestandteilliste in Montager Reihenfolge
Parts listed in order of assembly

1 = 1106	10 = 1246
2 = 1108	11 = 1110
3 = 1107	12 = 2504 (2x)
4 = 1109	13 = 1776
5 = 2417 (1x)	14 = 2351 (2x)
6 = 1111	15 = 1788
7 = 1112	16 = 1783
8 = 1113	17 = 1775
9 = 1113	18 = 2351 (2x)

Lubrification – Schmierung – Lubrication

	Huile fine Dünflüssiges Öl Fine oil	Moebius 9010
	Huile épaisse Dickflüssiges Öl Thick oil	Moebius D5
	Graisse Fett Grease	Moebius 9501

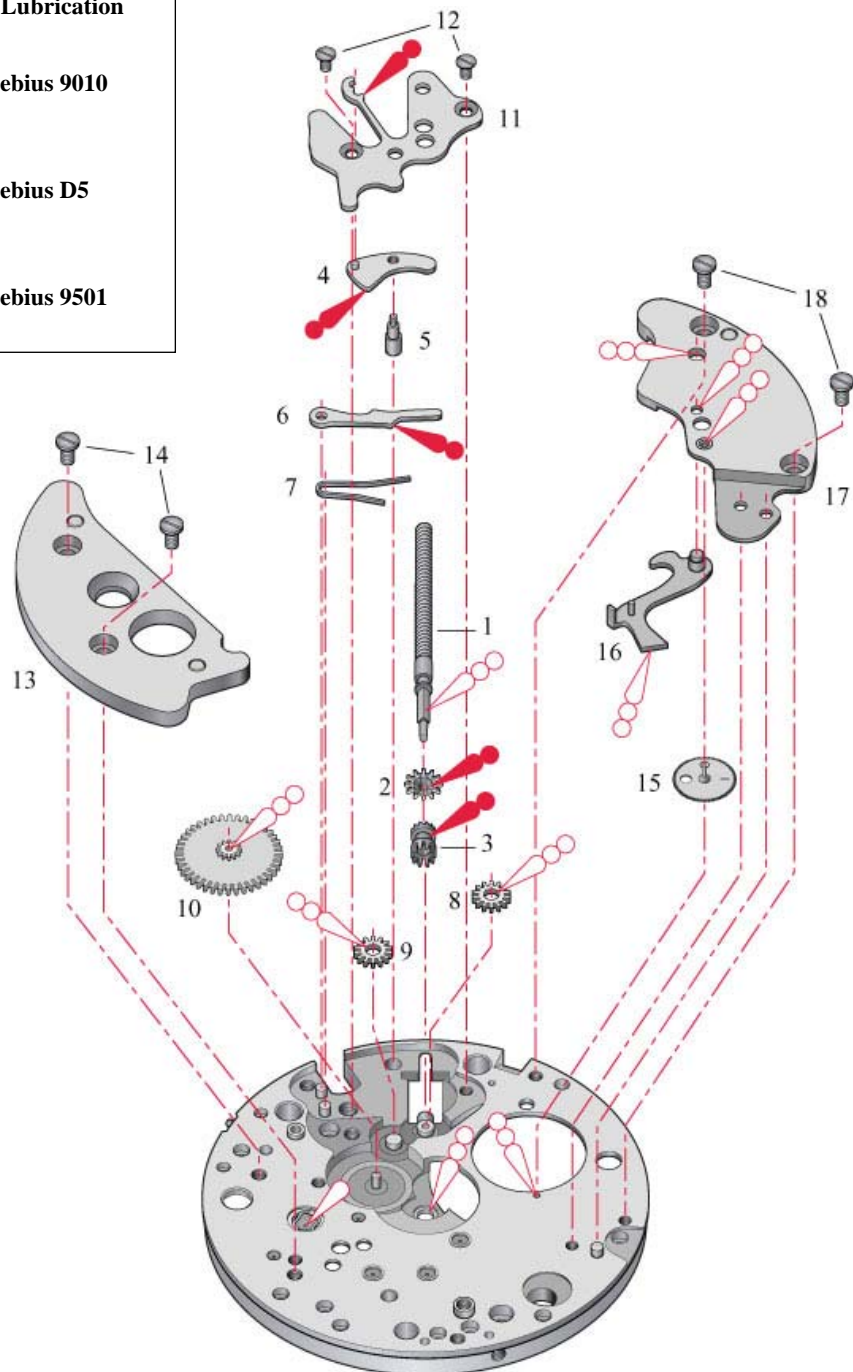

2. Liste de fournitures par ordre d'assemblage

Bestandteilliste in Montager Reihenfolge

Parts listed in order of assembly

1 = 1200	12 = 2033 (3x)
2 = 1100	13 = 1105
3 = 1243	14 = 2346 (1x)
4 = 1240	15 = 1305
5 = 1224	16 = 1004
6 = 1101	17 = 2033 (2x)
7 = 1102	18 = 1316
8 = 2510 (1x)	19 = 1005
9 = 1104	20 = 2224 (2x)
10 = 2345 (1x)	21 = 1030 / 1327
11 = 1002	22 = 2033 (1x)

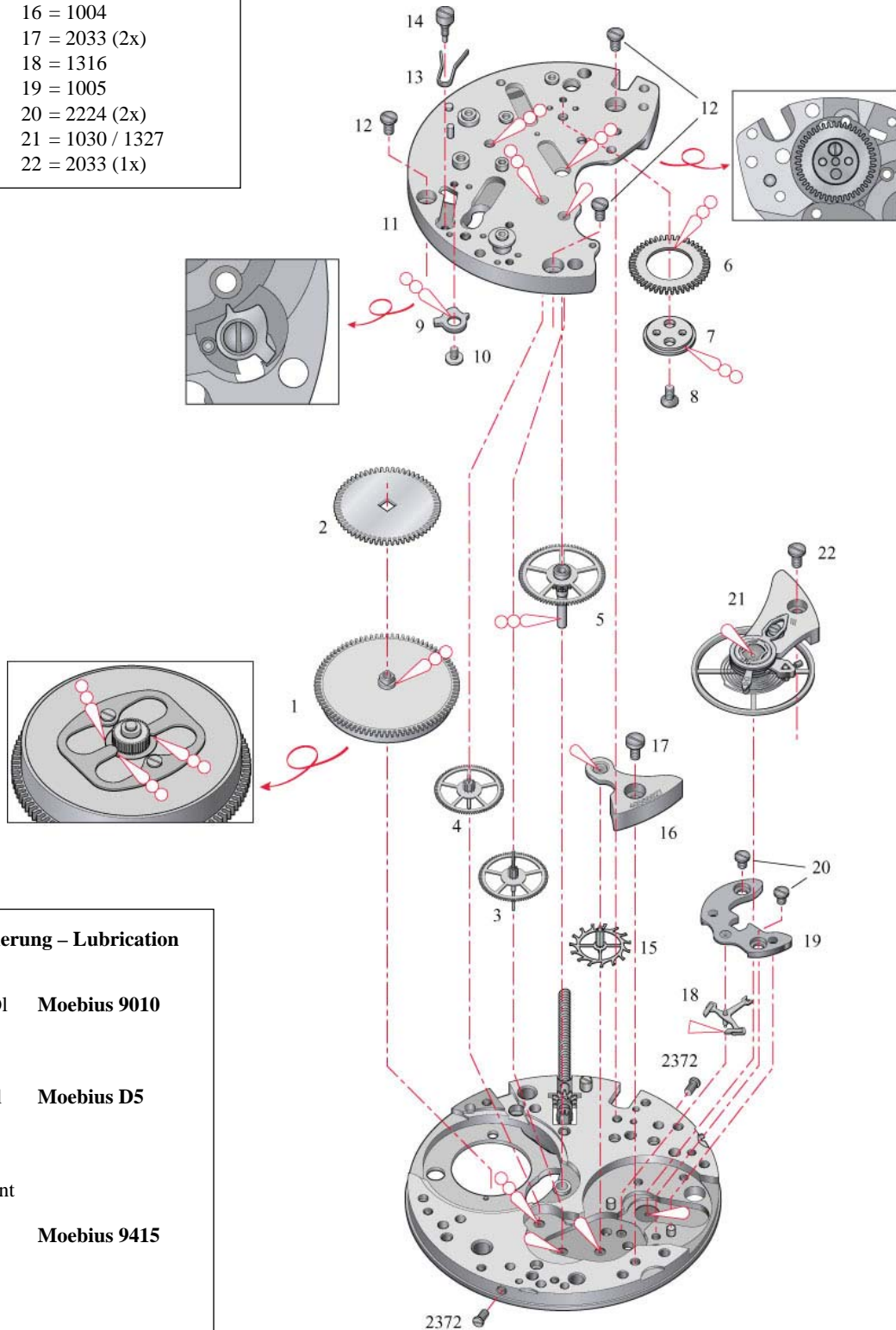





Lubrification – Schmierung – Lubrication

	Huile fine Dünflüssiges Öl Fine oil	Moebius 9010
	Huile épaisse Dickflüssiges Öl Thick oil	Moebius D5
	Graisse spéciale pour échappement Spezialfett für Hemmung Special grease for escapement	Moebius 9415
	Graisse Fett Grease	Moebius 9501

3. Liste de fournitures par ordre d'assemblage
Bestandteilliste in Montager Reihenfolge
Parts listed in order of assembly

1 = 1733	CONTR. 2
2 = 1759	19 = 1766
3 = 1752	20 = 1037
4 = 1843	21 = 2033 (1x)
5 = 1844	CONTR. 3
6 = 2545 (1x)	22 = 1726
7 = 1845	23 = 2544 (1x)
8 = 1842	24 = 1710
9 = 1841	CONTR. 4
10 = 2544 (1x)	25 = 1724
11 = 1840	26 = 2548 (1x)
12 = 1720	27 = 1731
13 = 2544 (2x)	28 = 2549 (1x)
14 = 1735	29 = 1734
15 = 2237	30 = 2555 (1x)
CONTR. 1	31 = 1728
16 = 1705	32 = 1774
17 = 1714	33 = 2354 (1x)
18 = 1708	

Lubrification – Schmierung – Lubrication

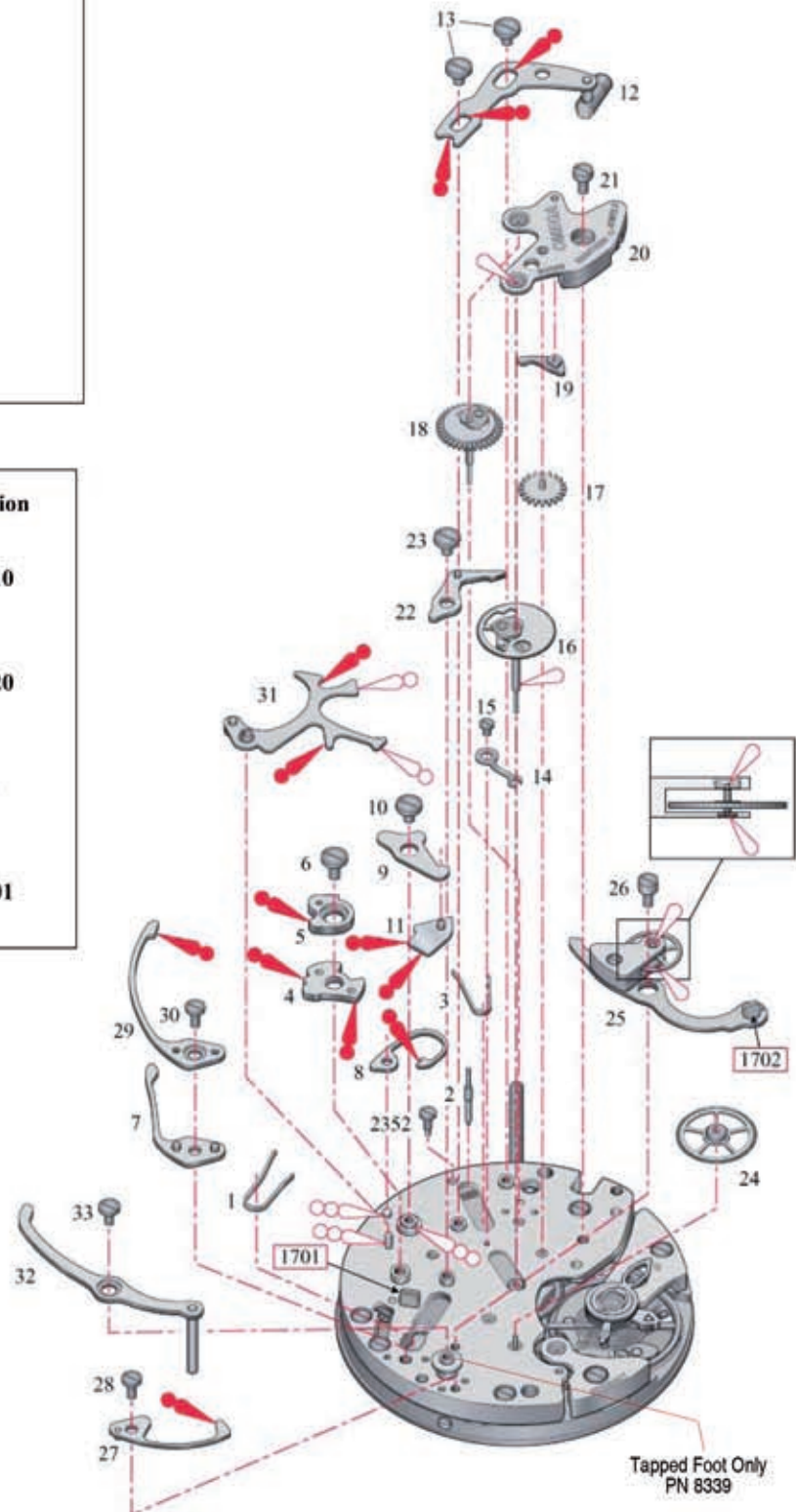

Huile fine	
 Dünnflüssiges Öl	Moebius 9010
Fine oil	
Huile moyenne	
 Mittelflüssiges Öl	Moebius 9020
Medium oil	
Huile épaisse	
 Dickflüssiges Öl	Moebius D5
Thick oil	
Graisse	
 Fett	Moebius 9501
Grease	



4. Liste de fournitures par ordre d'assemblage
Bestandteilliste in Montagerihenfolge
Parts listed in order of assembly

- | | |
|---------------|-----------------|
| 1 = 1799 | 9 = 2352 (1x) |
| 2 = 2353 (1x) | CONTR. 5 |
| 3 = 1793 | 10 = 1794 |
| 4 = 2350 (1x) | 11 = 2353 (1x) |
| 5 = 1750 | 12 = 1218 |
| 6 = 2357 (1x) | 13 = 1231 |
| 7 = 1784 | 14 = 1298 |
| 8 = 093.xxxx | |

Lubrification – Schmierung – Lubrication

- | | | |
|--|--|---------------------|
|  | Huile épaisse
Dickflüssiges Öl
Thick oil | Moebius D5 |
|  | Graisse
Fett
Grease | Moebius 9501 |

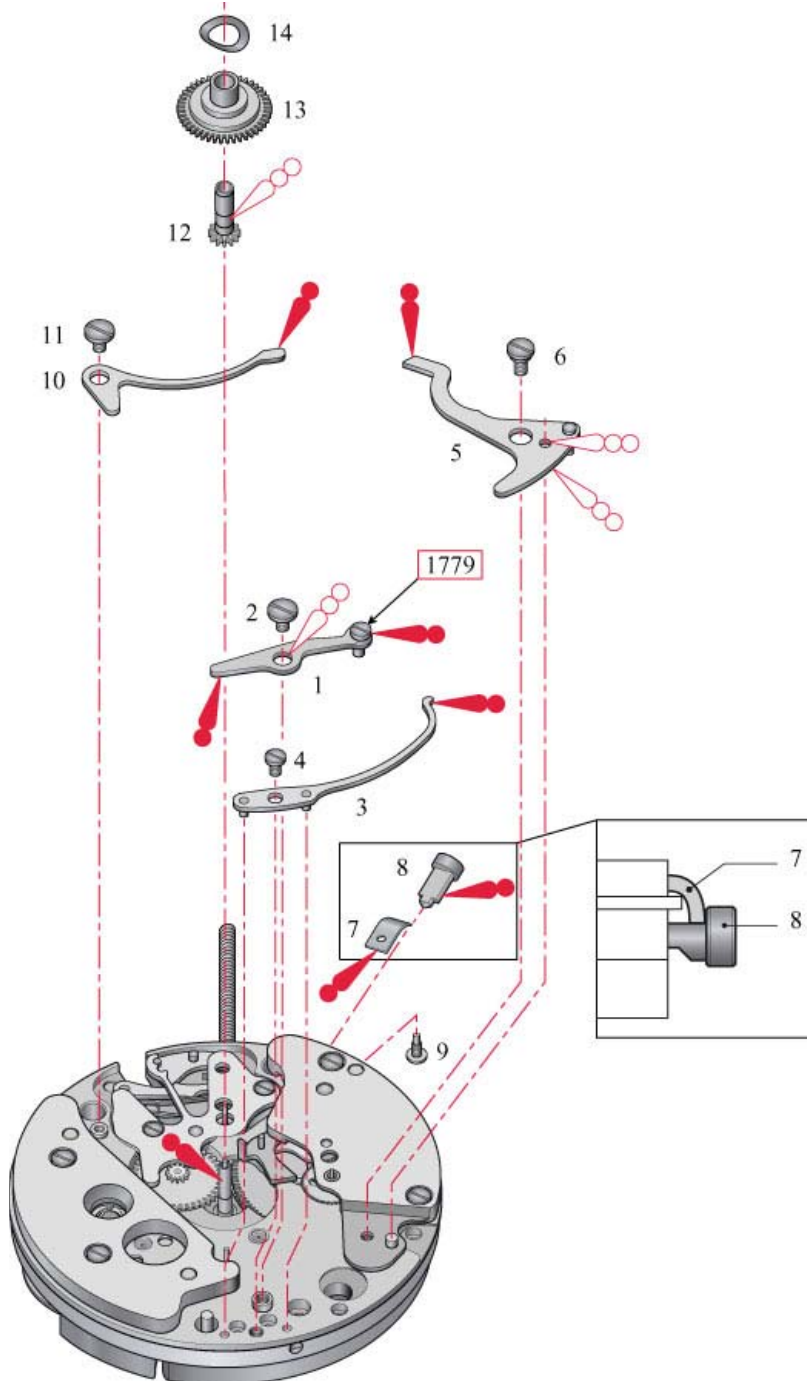

Contrôles à effectuer pendant l'assemblage

CONTR. 1

Bien loger la portée de la vis (2237) dans le ressort-friction de la roue de chronographe (1735).

Kontrollen während dem Zusammenbau

CONTR. 1

Die Lagerfläche der Schraube (2237) satt in die Reibungsfeder des Chronographenrades (1735) einrasten.

Controls during assembly

CONTR. 1

Carefully insert the bearing face of the screw (2237) in the friction spring of the chronograph wheel (1735).

Fig. 1

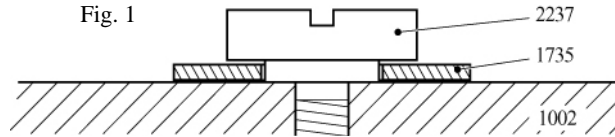

CONTR. 2

Contrôler l'armage du ressort de sautoir du compteur de minutes 1767 sous le pont de chronographe 1037 (Fig. 2).

CONTR. 2

Die Spannung der Feder für die Minutenzählrad-Sperre 1767 unter der Chronographenbrücke 1037 kontrollieren (Fig. 2).

CONTR. 2

Check the tension of the spring for minute recorder jumper 1767 under the chronograph bridge 1037 (Fig. 2).

Fig. 2

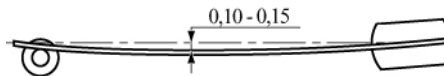

CONTR. 3

Contrôler la liberté du rouage du compteur de minutes en dégageant le sautoir 1766 et en projetant un jet d'air sur la roue de compteur de minutes 1708.

CONTR. 3

Freilaufkontrolle des Minutenzählwerks unter Auslösung der Radsperre 1766 und eines gleichzeitig auf das Minutenzählrad 1708 gerichteten Luftstromes.

CONTR. 3

Check the freedom of the minute recording gear while disengaging the minute recorder jumper 1766 and by projecting an air jet on the minute-recorder runner 1708.

CONTR. 4

Vérifier le plat de la roue entraîneuse de chronographe 1710.

CONTR. 4

Den Flachlauf des Chronograph-Mitnehmerrades 1710 kontrollieren.

CONTR. 4

Verify that the driving wheel for chronograph 1710 runs truly flat.

CONTR. 5

Dévisser suffisamment la vis de tige de poussoir de mise à zéro (2352) pour laisser passer la tige de poussoir de remise à zéro (093.xxxx) sous le pont de barillet et de rouage (1002).

CONTR. 5

Die Nullstelldrückerschaft-Schraube (2352) genügend ausschrauben, um den Nullstelldrückerschaft (093.xxxx) unter der Federgehäuse-/Räderwerk-Brücke durchzulassen.

CONTR. 5

Unscrew the zero setting push-piece stem screw (2352) sufficiently to allow the zero reset push-piece stem (093.xxxx) to pass under the barrel and gear-train bridge (1002).

Contrôles et ajustements à effectuer après l'assemblage

Contrôler les pénétrations d'engrenages (Fig. 3)

Ce contrôle s'effectue sur un tour complet.

La roue d'embrayage 1712 doit pénétrer jusqu'aux 2/3 de la denture de la roue entraîneuse de chronographe 1710. A régler par l'excentrique 1702.

La roue d'embrayage 1712 doit pénétrer jusqu'au 1/3 de la denture de la roue de chronographe 1705. A régler par l'excentrique 1701.

Kontrollen und Einstellungen nach dem Zusammenbau

Einstellung der Eingriffe (Fig. 3)

Die Kontrolle erstreckt sich über eine vollständige Umdrehung.

Die Tiefe des Eingriffes zwischen dem Mitnehmerrad 1710 und dem Kupplungsrad 1712 wird mittels dem drehbaren Exzenter 1702 auf ungefähr zwei Drittel der Zahnhöhen eingestellt.

Der Eingriff des Kupplungsrades 1712 soll nicht tiefer als ein Drittel der Zahnhöhe des Chrono-Zentrumrades 1705 sein. Die Einstellung erfolgt mit dem Exzenter 1701.

Controls and adjustments after assembly

Check the penetration of the gear (Fig. 3)

This inspection must be carried out through one complete revolution.

The penetration of the coupling wheel 1712 and the driving wheel for chronograph 1710 should be limited to 2/3 of the height of the teeth and can be adjusted by turning the clutch eccentric 1702.

The coupling wheel 1712 should penetrate 1/3 of the teeth height of the chronograph runner 1705. Adjust by means of eccentric 1701.

Fig. 3

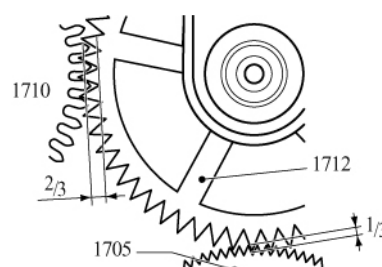

Contrôler les accordages (Fig. 4)

Ayant fait la remise à zéro, la roue de chronographe 1705 doit être bloquée par le marteau 1728 qui appuie sur son cœur. Par contre, entre le cœur du compteur de minutes 1708 et le marteau 1728, il doit y avoir un petit jour. Celui-ci se contrôle en 2 phases :

1. Le sautoir du compteur de minutes 1766 doit appuyer sur 2 dents de la roue de compteur de minutes 1708.
2. La régularité du jour est contrôlée en tournant, dans les deux sens, la roue de compteur de minutes 1708, d'un petit angle, jusqu'à la résistance du marteau ; le déplacement du sautoir 1766 doit être égal sur chacune des dents et ne pas arriver à moins de 0,10 mm de la pointe de la dent.

Vérifier que le marteau 1728 ne touche ni aux roues, ni au pont de chronographe 1037.

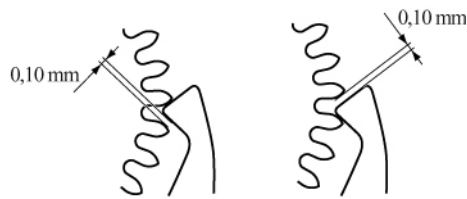
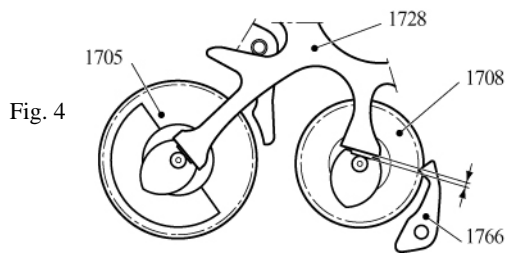

Kontrolle der Herzhebelabstimmung (Fig. 4)

In der Nullstellung drückt der Herzhebel 1728 gegen das Sekundenherz und blockiert somit das Chrono-Zentrumrad 1705. Demgegenüber muss zwischen dem Herzhebel 1728 und dem Minutenherz 1708 ein geringer Abstand bestehen, der in 2 Phasen wie folgt zu kontrollieren ist :

1. Die Minutenzählradsperr 1766 muss gegen zwei Zähne des Minutenzähl-rades 1708 drücken.
2. Zu Kontrolle der Abstände wird das Minutenzählrad 1708 nach beiden Richtungen gedreht, bis ein leichter Widerstand verspürt wird. Die dabei entstehende Verschiebung der Zählradsperr 1766 muss auf jedem Zahn gleich sein und dabei mindestens 0,10 mm in die Zähne einrasten.

Der Herzhebel 1728 darf weder die Räder noch die Chronobrücke 1037 berühren.

Checking the accordment (Fig. 4)

At zero position the hammer 1728 presses against the chrono heart-piece, thus blocking the chronograph runner 1705. Contrarily, a slight clearance between the hammer 1728 and the heart-piece of the minute runner 1708 must exist. This clearance has to be checked in two stages :

1. The minute jumper 1766 must rest on two teeth of the minute runner 1708.
2. To check the regularity of the clearance, slightly move the minute runner 1708 in both directions, until the resistance of the hammer 1766 is felt. The displacement of the jumper should be equal on each tooth, but engage not less than 0.10 mm of the height of the tooth.

Verify that the hammer 1728 is neither fouling the wheels nor the chronograph bridge 1037.

Contrôler la position du doigt (Fig. 5)

Ayant fait la remise à zéro, il doit rester un léger jeu entre la pointe de la roue intermédiaire du compteur minutes 1714 et le plat du doigt A (contrôler par le regard du pont de chronographe 1037). Après l'aiguillage, contrôler que l'aiguille compteur minutes saute lorsque l'aiguille chronographe passe sur midi.

Kontrolle der Schaltfingerstellung (Fig. 5)

In der Nullstellung besteht zwischen der Zahnschnecke des Zwischenrades des Minutenzählers 1714 und der Finger-flanke A ein geringer Abstand (gesehen durch das Kontrollfenster in der Chronographbrücke 1037). Nach dem Zeigersetzen ist zu kontrollieren, ob der Minutenzähler zusammen mit dem über 12 Uhr laufenden Sekundenzeiger springt.

Checking the position of finger-piece (Fig. 5)

At zero position, a slight clearance between the teeth of the intermediate wheel for the minute counter 1714 and the flat part of the finger A must be visible (seen through the hole of the chronograph bridge 1037). After fitting the hands, check that the minute recorder hand jumps when the chronograph hand passes over midday.

Fig. 5

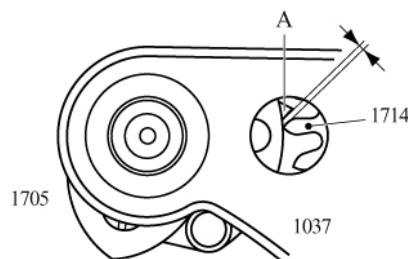

Contrôler l'isolateur de bloqueur (Fig. 6)

Mettre le chronographe en position stop : il doit y avoir un jeu entre l'isolateur de bloqueur (marteau 1728) et la goupille du bloqueur 1726.

Kontrolle des Herzhebelisolators (Fig. 6)

In der Stopp-Position muss ein geringer Abstand zwischen dem Herzhebel-isolator (1728) und dem Blockierstift 1726 vorhanden sein.

Checking the isolator of the blocking lever (Fig. 6)

Stop the chronograph and check the clearance between the isolator (hammer 1728) and the stud of the blocking lever 1726.

Fig. 6

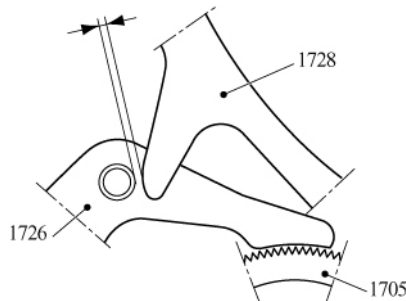

Contrôler la levée du marteau (Fig. 7)

Mettre le chronographe en prise : il doit y avoir un jeu entre le bec d'accrochement (marteau 1728) et la goupille d'accrochement 1759.

Kontrolle der Hammerhebung (Fig. 7)

Mit dem Chronograph im Eingriff muss zwischen dem Herzhebelhaken (1728) und dem Herzhebelriegel 1759 ein geringer Abstand bestehen.

Checking the lifting of the hammer (Fig. 7)

With the chronograph engaged, a slight side-play must be noticeable between the rack-hook of the hammer 1728 and the stem-bolt 1759.

Fig. 7

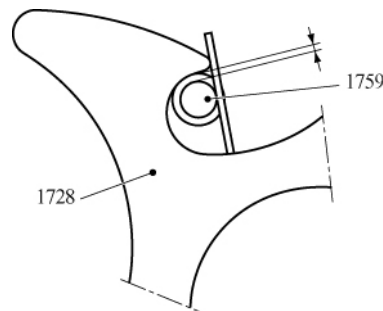

Contrôler les fonctions du compteur d'heures (Fig. 8)

Mettre le chronographe en prise et régler l'excentrique de l'interrupteur 1779 de façon à ce que l'extrémité du marteau d'heures 1783 vienne buter sur l'extrémité du sabot 1750 lorsque l'on presse sur le poussoir B de remise à zéro.

Mettre le chronographe en position stop. L'interrupteur 1779 doit avoir un léger jeu avec le sabot 1750.

En pressant sur le poussoir de remise à zéro, contrôler que la roue du compteur d'heures 1788 soit bloquée.

Kontrolle der Funktionen des Stundenzählers (Fig. 8)

Starten des Chronographen und Einstellen des Exzenters des Unterbrechers 1779 so, dass beim Nullstellen die Schulter des Stundenherzhebels 1783 gegen das Ende des Stopphebels 1750 zu liegen kommt.

In der Stopp-Position muss zwischen dem Unterbrecher 1779 und dem Stopphebel 1750 ein leichtes Spiel bestehen.

In der Nullstellung ist zu kontrollieren, ob das Stundenzählrad 1788 richtig blockiert ist.

Checking the functions of the hour counter (Fig. 8)

Start the chronograph and adjust eccentric for switch 1779 so, that the point of the hour hammer 1783 strikes on to the extremity of the hour recorder stop lever 1750 when depressing push-piece for zero action.

Stop the chronograph and check that there is a slight play between switch 1779 and stop lever 1750.

Depress the push-piece for zero action and check that the hour recording runner 1788 is properly blocked.

Fig. 8

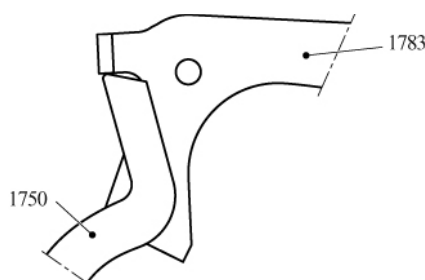

Informations concernant les fournitures dépendant du type de boîte

1. La commande montée 860.1720 est livrée avec 3 rallonges. Selon le type de boîte, il faut utiliser la commande sans rallonge ou chasser celle des trois rallonges dans la commande qui s'adapte à la boîte (poussoir départ/arrêt).
2. La tige de poussoir de remise à zéro 093STxxxx existe en 4 longueurs. Il faut utiliser celle qui s'adapte à la boîte (poussoir de remise à zéro).

Exemples :

a) Réf. 145.0022 :

- La commande 860.1720 avec rallonge 0,75 mm (093ST0025).
- Tige de poussoir de remise à zéro 093ST0016 (4,45 mm).

b) Réf. 145.0050 :

- Commande 860.1720 sans rallonge.
- Tige de poussoir de remise à zéro 093ST0023 (3,75 mm).

Information betreffend der vom Gehäusotyp abhängigen Ersatzteile

1. Der Schalthebel, montiert, 860.1720 wird mit 3 Verlängerungen geliefert. Je nach Gehäusotyp wird der Schalthebel ohne Verlängerung verwendet oder die entsprechende Verlängerung in den Schalthebel eingepresst (Start/Stop-Drücker)
2. Die Nullstellwelle 093STxxxx existiert in 4 Längen. Es ist diejenige zu verwenden, die zum entsprechenden Gehäuse passt (Nullstelldrücker).

Beispiel :

a) Ref. 145.0022 :

- Schalthebel 860.1720 mit Verlängerung 0,75 mm (093ST0025).
- Nullstellwelle 093ST0016 (4,45 mm).

b) Ref. 145.0050 :

- Schalthebel 860.1720 ohne Verlängerung.
- Nullstellwelle 093ST0023 (3,75 mm).

Information on spare-parts depending on the case type

1. The mounted operating lever 860.1720 is supplied with 3 extensions. Depending on the case type, the operating lever is used without extension or the corresponding extension has to be pressed into the operating lever (start/stop pusher).
2. The pusher stem for zero action 093STxxxx exists in 4 different lengths. Use the one which adapts to the case (zero reset pusher).

Examples :

a) Ref. 145.0022 :

- Operating lever 860.1720 with extension 0.75 mm (093ST0025).
- Pusher stem for zero action 093ST0016 (4.45 mm).

b) Ref. 145.0050 :

- Operating lever 860.1720 without extension.
- Pusher for zero action 093ST0023 (3.75 mm).

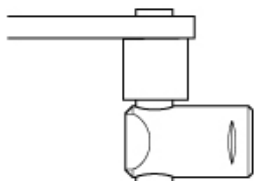
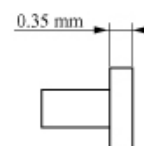
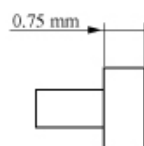
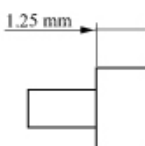
Commande montée Schalthebel montiert Operating lever mounted	Rallonges Verlängerungen Extensions		
 860.1720	 093ST0024	 093ST0025	 093ST0026

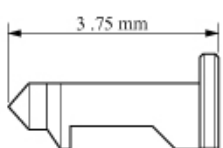
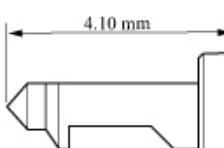
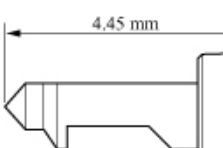
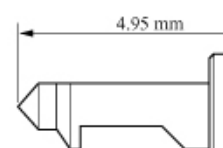
Tiges de poussoir de remise à zéro Nullstellwellen Pusher stems for zero action			
 093ST0023	 093ST0015	 093ST0016	 093ST0017

Réglage – Regulierung – Timing

Démagnétiser le mouvement avant les contrôles.

Das Werk ist vor den Prüfungen zu entmagnetisieren.

Demagnetize the movement before the checks.

Positions de réglage:

Kontrollpositionen:

Timing positions:

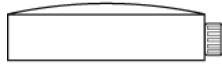

HH

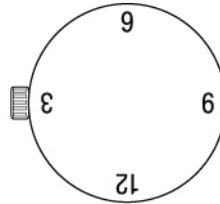

VG

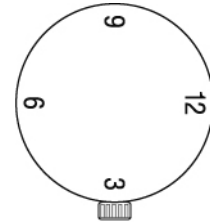

VB

Alternances: 21'600 A/h
Angle de levée: 50°
Réserve de marche: 45 heures
Perte d'amplitude maximum avec chronographe en marche: 40°

Halbschwingungen: 21'600 A/h
Hebungswinkel: 50°
Gangreserve: 45 heures
Maximaler Amplitudenverlust bei eingeschaltetem Chronographen: 40°

Frequency: 21'600 A/h
Angle of lift: 50°
Power reserve: 45 hours
Maximum loss of amplitude with chronograph in operation: 40°

	MM 0 h	Δ 0 h	MM 24 h	Δ 24 h	Ampl. 24 h VB	Réserve de marche Gangreserve Power reserve
Limites (sans chronographe) Limiten (ohne Chronograph) Limits (without chronograph)	0 / + 10	15 sec.	0 / + 12	22 sec.	190°	45 h

MM 0 h: Marche moyenne dans les positions à 0 heure (entre 30 et 90 minutes après le remontage complet).

MM 0 h: Mittlerer Gang der Positionen bei 0 Uhr (zwischen 30 und 90 Minuten nach Vollaufzug).

MM 0 h: Average rate in the positions at 0 hour (between 30 and 90 minutes after complete winding).

0 h: La plus grande différence de marche dans les 5 positions à 0 heure (entre 30 et 90 minutes après le remontage).

0 h: Größte Gangdifferenz der 5 Positionen bei 0 Uhr (zwischen 30 und 90 Minuten nach Vollaufzug).

0 h: The biggest rate difference in the 5 positions at 0 hour (between 30 and 90 minutes after complete winding).

24 h: La plus grande différence de marche dans les positions après 24 heures (entre 23 h 30 et 25 heures après le remontage complet).

24 h: Größte Gangdifferenz der Positionen nach 24 Stunden (zwischen 23 h 30 und 25 Stunden nach Vollaufzug).

24 h: The biggest rate difference in the positions after 24 hours (between 23 h 30 and 25 hours after complete winding).











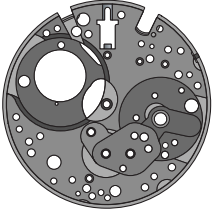
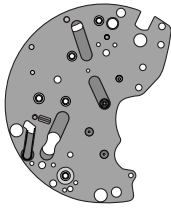





























































Ampl. 24 h: Amplitude minimum en position verticale après 24 heures.

Ampl. 24 h: Minimale Amplitude in vertikaler Positionen nach 24 Stunden.

Ampl. 24 h: Minimum amplitude in vertical position after 24 hours.

Liste des fournitures – Bestandteilliste – Spare parts list

Mouvement de base – Basiswerk – Basic movement

































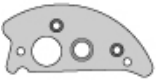































																	
1000	1002	1004	1005	1030	1037												
																	
1100	1101	1102	1104	1105	1106	1107	1108	1109	1110	1111	1112	1113					
																	
1200	1204	1208	1216	1218	1224	1231	1240	1243	1246	1298	1305	1316	1321	1324	1327	1331	1332
																	
1339	1341	1342	1344	1346	1347	1350	1363	8026	8027	8028	8338	8339	8349	T4 80 120	T4 80 180	T5 70 265	
																	
2033	2159	2224	2345	2346	2372	2417	2504	2510	2553	2553							
																	
4067	4068	4069	4070	4140	4146	6177	6180										

Cal.	No CS	Désignation	Bezeichnung	Designation
861	1000/J	Platine (jaune)	Werkplatte (gelb)	Main plate (yellow)
861	1000R	Platine (rose)	Werkplatte (rosa)	Main plate (pink)
861	1002/J	Pont de barillet et de rouage (jaune) (3/4 platine)	Federhaus und Räderwerkbrücke (gelb) (3/4 Werkplatte)	Barrel and train wheel bridge (yellow) (3/4 plate)
861	1002	Pont de barillet et de rouage (rose) (3/4 platine)	Federhaus und Räderwerkbrücke (rosa) (3/4 Werkplatte)	Barrel and train wheel bridge (pink) (3/4 plate)
860	1004/J	Pont de roue d'échappement (jaune)	Hemmungsräderbrücke (gelb)	Escape wheel bridge (yellow)
860	1004	Pont de roue d'échappement (rose)	Hemmungsräderbrücke (rosa)	Escape wheel bridge (pink)
860	1005/J	Pont d'ancre (jaune)	Ankerbrücke (gelb)	Pallet bridge (yellow)
860	1005	Pont d'ancre (rose)	Ankerbrücke (rosa)	Pallet bridge (pink)
861	1030J	Coq (jaune)	Unruhbrücke (gelb)	Balance cock (yellow)
860	1030	Coq (rose)	Unruhbrücke (rosa)	Balance cock (pink)
860	1037/J	Pont de chronographe (jaune)	Chronographbrücke (gelb)	Chronograph bridge (yellow)
860	1037	Pont de chronographe (rose)	Chronographbrücke (rosa)	Chronograph bridge (pink)
320	1100	Rochet	Sperrrad	Ratchet wheel
860	1101	Roue de couronne	Kronrad	Crown wheel
860	1101A	Roue de couronne et noyau de roue de couronne	Kronrad und Kronradkern	Crown wheel and crown wheel core
860	1102	Noyau de roue de couronne	Kronradkern	Crown wheel core
320	1104	Cliquet	Sperrkegel	Click
320	1105	Ressort de cliquet	Sperrkegelfeder	Click spring
860	1106	Tige de remontoir	Aufzugswelle	Winding stem
860	1107	Pignon coulant	Schiebetrieb	Sliding pinion
860	1108	Pignon de remontoir	Aufzugtrieb	Winding pinion

Cal.	No CS	Désignation	Bezeichnung	Designation
860	1109	Tirette (verrou)	Winkelhebel (Riegel)	Setting lever (bolt)
860	1110	Ressort de tirette	Winkelhebelfeder	Setting lever spring
320	1111	Bascule	Wippe	Yoke
320	1112	Ressort de bascule	Wippenfeder	Yoke spring
860	1113	Renvoi	Zeigerstellrad	Setting wheel
861	1200	Barillet avec arbre, pignon entraîneur et ressort-friction	Federhaus mit Federwelle, Mitnehmertrieb und Friktionsfeder	Barrel with arbor, driving pinion and friction spring
861	1204	Arbre de barillet	Federwelle	Barrel arbor
860	1208	Ressort de barillet	Zugfeder	Mainspring
861	1216	Roue de centre, H1	Minutenrad, H1	Center wheel, H1
861	1218	Chaussée, H1	Minutenrohr, H1	Cannon pinion, H1
861	1224	Roue de centre avec chaussée, H1	Minutenrad mit Minutenrohr, H1	Center wheel with cannon pinion, H1
861	1231	Roue des heures, H1	Stundenrad, H1	Hour wheel, H1
320	1240	Roue moyenne	Kleinbodenrad	Third wheel
861	1243	Roue de seconde, H1	Sekundenrad, H1	Fourth wheel, H1
320	1246	Roue de minuterie	Wechselrad	Minute wheel
320	1298	Clinquant 4 1/2	Flitter 4 1/2	Metal foil 4 1/2
860	1305	Roue d'échappement pivotée	Ankerrad mit Trieb	Escape wheel, pivoted
860	1316	Ancre montée	Anker mit Welle	Jewelled pallet fork and staff
860	1321	Axe de balancier	Unruhwelle	Balance staff, pivoted
860	1324	Plateau garni	Hebelscheibe, montiert	Roller, complete
860	1327	Balancier avec spiral	Unruh mit Spirale	Balance with hairspring, regulated
860	1331	Raquette (cercle de raquette)	Rücker (Rückerring)	Regulator (regulator ring)
860	1332	Flèche de raquette (corps de raquette)	Rückerstiel (Rückerkörper)	Regulator pointer (regulator body)
710	1339	Régulateur de raquette	Rückerregler	Adjuster for regulator
860	1341	Chatons, dessus - dessous	Steinfutter, oben - unten	In settings, upper - lower
860	1342	Pierre de contre-pivot de balancier, dessus - dessous	Deckstein für Unruh, oben - unten	Cap jewel for balance, upper - lower
860	1344	Fixateur du contre-pivot, dessus	Halter für Zapfendecke, oben	End-piece holder, upper
860	1346	Amortisseur empierré, de balancier dessous, à chasser, cylindrique	Stossicherung, mit Stein, für Unruh, unten, zum Einpressen, zylindrisch	Jewelled shock-absorber for balance, bottom, to press-in, cylindrical
860	1347	Amortisseur empierré, de balancier dessus, à chasser, à portée	Stossicherung, mit Stein, für Unruh, oben, zum Einpressen, mit Auflage	Jewelled shock-absorber for balance top, to press-in, shouldered
860	1350	Fixateur du contre-pivot, dessous	Halter für Zapfendecke, unten	End-piece holder, lower
269	1363/J	Porte-piton (jaune)	Spiralklötzenträger (gelb)	Stud-holder (yellow)
269	1363	Porte-piton (rose)	Spiralklötzenträger (rosa)	Stud-holder (pink)
860	8349	Bouchon de renvoi	Zapfenfutter für Zeigerstellrad	Bushing for setting wheel
861	8026	Pied taraudé pour bascule de commande	Gewindebuchse für Schalthebelwippe	Tapped foot for operating lever yoke
861	8027	Pied taraudé pour la commande	Gewindebuchse für Schalthebel	Tapped foot for operating lever
861	8027	Pied taraudé pour l'interrupteur	Gewindebuchse für Unterbrecher	Tapped foot for switch
861	8027	Pied taraudé pour le ressort de marteau d'heures	Gewindebuchse für Stundenherzhebelfeder	Tapped foot for hour hammer spring
861	8028	Pied taraudé pour la navette inf./sup.	Gewindebuchse für Blockierhebel	Tapped foot for lower/upper cam
861	8338	Pied taraudé pour le bloqueur	Gewindebuchse für Stundenzählradwippe	Tapped foot for lock
861	8339	Pied taraudé pour la bascule de compteur d'heures	Stellstift für Schalthebelfeder	Tapped foot for hour recorder yoke
861 T480	120	Pied du ressort de commande	Stellstift für Stundenzähler-Stopphebel	Foot for operating lever spring
861 T480	180	Pied pour le sabot (bloqueur de marteau d'heures)	Stellstift für Herzhebel	Foot for hour recorder stop lever
861 T570	265	Pied pour le marteau		Foot for hammer
0000	2033	Vis de pont de barillet (3/4 platine)	Schraube für Federhausbrücke (3/4 Werkplatte)	Screw for barrel bridge (3/4 plate)
0000	2033	Vis de pont de roue d'échappement	Schraube für Ankerradbrücke	Screw for escape wheel bridge
0000	2033	Vis de coq	Schraube für Unruhbrücke	Screw for balance bridge
0000	2159	Vis de piton	Schraube für Spiralklötchen	Screw for stud for hairspring
0000	2224	Vis de pont d'ancre	Schraube für Ankerbrücke	Screw for pallet bridge
0000	2345	Vis de cliquet	Schraube für Sperrkegel	Screw for click
0000	2346	Vis de ressort de cliquet	Schraube für Sperrkegelfeder	Screw for click spring
0000	2372	Vis de cadran	Schraube für Zifferblatt	Screw for dial
0000	2417	Vis de tirette	Schraube für Stellhebel	Screw for setting lever
0000	2504	Vis de ressort de tirette	Schraube für Stellhebelfeder	Screw for setting lever spring
0000	2510	Vis de noyau de roue de couronne	Schraube für Kronradkern	Screw for crown wheel core
107	2553	Vis de bride de fixation (tête arrondie)	Schraube für Werkbefestigungsbügel (Rundkopf)	Screw for casing clamp (convex head)
107	3163	Vis de bride de fixation (tête plate)	Schraube für Werkbefestigungsbügel (Flachkopf)	Screw for casing clamp (flat head)
0000	4067	Pierre d'ancre, dessus - dessous	Stein für Anker, oben - unten	Jewel for pallet staff, upper - lower
0000	4068	Pierre de roue d'échappement, dessus - dessous	Stein für Ankerrad, oben - unten	Jewel for escape wheel, upper - lower
0000	4069	Pierre de roue moyenne, dessus - dessous	Stein für Kleinbodenrad, oben - unten	Jewel for third wheel, upper - lower
0000	4070	Pierre de mobile de chronographe, dessus	Stein für Chronograph-Zentrumrad, oben	Jewel for chronograph runner, upper
0000	4070	Pierre du mobile de compteur de minutes, dessus	Stein für Minutenzählrad, oben	Jewel for minute-recording runner, upper
0000	4140	Pierre de roue de seconde, dessous	Stein für Sekundenrad, unten	Jewel for fourth wheel, lower
0000	4140	Pierre de roue de seconde, dessus	Stein für Sekundenrad, oben	Jewel for fourth wheel, upper
0000	4146	Bouchon de roue d'embrayage, dessus - dessous	Zapfenfutter für Kupplungsrad, oben - unten	Bushing for coupling wheel, upper - lower
0000	6177	Bouchon de roue intermédiaire du compteur de minutes, dessus - dessous	Zapfenfutter für Zwischenrad des Minutenzählers, oben - unten	Bushing for intermediate wheel minute recording, upper - lower
0000	6177	Bouchon de roue de compteur d'heures, dessus	Zapfenfutter für Stundenzählrad, oben	Bushing for hour-recording wheel, upper

Liste des fournitures – Bestandteilliste – Spare parts list

Chronographe – Chronograph – Chronograph

									
1701	1702	1705	1708	1710	1712	1714	1716	1720	
									
1724	1726	1728	1731	1733	1734	1735			
									
1750	1752	1759	1766	1767	1774	1775			
									
1776	1779	1783	1784	1788	1791	1792			
									
1793	1794	1840	1841	1842	1843	1844	1845		
									
093ST0015	093ST0016	093ST0017	093ST0023	093ST0024	093ST0025	093ST0026			
									
2033	2237	2243	2245	2350	2351	2352	2353	2354	2355
									
2357	2358	2513	2515	2544	2545	2547	2548	2549	2552

Cal.	No CS	Désignation	Bezeichnung	Designation
860	1701	Excentrique d'appui d'embrayage	Exzenter für Kupplungs-Anschlag	Banking stop eccentric for coupling clutch
860	1702	Excentrique de pivotement d'embrayage	Exzenter für Kupplungs-Schwenkung	Eccentric for pivoting of coupling clutch
861	1705	Roue de chronographe, montée	Chronograph-Zentrumrad, montiert	Chronograph runner, mounted
861	1708	Roue du compteur de minutes, montée	Minutenzählrad, montiert	Minute-recording runner, mounted
320	1710	Roue entraîneuse de chronographe	Chronograph-Mitnehmerrad	Driving wheel for chronograph
860	1712	Roue d'embrayage avec tige	Kupplungsrad	Coupling wheel
860	1714	Roue intermédiaire de compteur de minutes, montée	Zwischenrad des Minutenzählers, montiert	Runner intermediate wheel minute recording, mounted
860	1716	Pont de roue d'embrayage	Brücke für Kupplungsrad	Coupling wheel bridge
860	1720	Commande avec 3 rallonges	Schalthebel mit 3 Verlängerungen	Operating lever with 3 extensions
860	1724	Bascule d'embrayage, montée	Kupplungswippe, montiert	Coupling yoke, mounted
860	1726V2	Bloqueur	Blockierhebel	Blocking lever
860	1728	Marteau, monté	Herzhebel, montiert	Hammer, mounted
860	1731	Ressort d'embrayage	Kupplungsfeder	Coupling clutch spring
860	1733	Ressort de bloqueur	Blockierhebelfeder	Blocking lever spring
860	1734	Ressort de marteau	Herzhebelfeder	Hammer spring
860	1735	Ressort-friction du mobile de chronographe	Friktionsfeder für Chronograph Zentrumrad	Friction spring for chronograph runner
861	1750	Sabot (bloqueur du compteur d'heures)	Stundenzähler-Stopphebel	Hour recorder stop lever
860	1752	Ressort de tige-verrou de marteau	Feder für Herzhebel-Riegelwelle	Stem-bolt spring for hammer
861	1759	Tige verrou de marteau	Herzhebel-Riegelwelle	Stem-bolt for hammer
860	1766	Sautoir du compteur des minutes	Herzhebel-Riegelwelle Minutenzählrad-Sperre	Minute-recording jumper

Cal.	No CS	Désignation	Bezeichnung	Designation
860	1767	Ressort du sautoir du compteur des minutes, monté	Feder für Minutenzählrad-Sperre, montiert	Spring for minute recording jumper, mounted
861	1774	Bascule de compteur d'heures, montée	Stundenzählradwippe, montiert	Hour recorder yoke, mounted
861	1775J	Pont de compteur d'heures (jaune)	Stundenzählradbrücke (gelb)	Hour recorder bridge (yellow)
861	1775	Pont de compteur d'heures (rose)	Stundenzählradbrücke (rosa)	Hour recorder bridge (pink)
861	1776J	Pont d'appui de cadran (jaune)	Stützbrücke für Zifferblatt (gelb)	Supporting-bridge for dial (yellow)
861	1776	Pont d'appui de cadran (rose)	Stützbrücke für Zifferblatt (rosa)	Supporting-bridge for dial (pink)
861	1778	Excentrique de l'interrupteur	Exzenter für Kupplungs-Ausschaltung	Clutch uncoupling eccentric
861	1779	Interrupteur, monté	Unterbrecher, montiert	Switch, mounted
321	1783	Marteau d'heures, monté	Stundenherzhebel, montiert	Hour hammer, mounted
861	1784	Commande du marteau d'heures	Schaltorgan für Stundenherzhebel	Operating lever for hour hammer
321	1788	Roue du compteur d'heures, monté	Stundenzählrad, montiert	Hour recording runner, mounted
861	1791	Pignon entraîneur, monté (compteur d'heures)	Mitnehmertrieb, montiert (Stundenzählrad)	Driving pinion, mounted (hour recorder)
321	1792	Ressort-friction du pignon entraîneur (compteur d'heures)	Friktionsfeder des Mitnehmertriebes (Stundenzählrad)	Friction spring for driving pinion (hour recorder)
861	1793	Ressort de sabot (du bloqueur du compteur d'heures)	Stundenzähler-Stopphebelfeder	Spring for hour recorder stop lever
861	1794	Ressort du marteau d'heures	Stundenherzhebelfeder	Hour hammer spring
860	1840	Commande intermédiaire	Verbindungsschalthebel	Connecting lever
860	1841	Bascule de commande	Schalthebelwippe	Operating lever yoke
860	1842	Ressort de commande	Schalthebelfeder	Operating lever spring
860	1843	Navette inférieure	Unterer Exzenter für Kupplung	Lower cam for coupling clutch
861	1844	Navette supérieure	Oberer Exzenter für Herzhebel	Upper cam for hammer
860	1845	Sautoir de navette	Exzenter Sperre	Cam jumper
093ST0015		Tige de poussoir de remise à zéro 4,10 mm	Nullstellwelle 4,10 mm	Pusher stem for zero action 4.10 mm
093ST0016		Tige de poussoir de remise à zéro 4,45 mm	Nullstellwelle 4,45 mm	Pusher stem for zero action 4.45 mm
093ST0017		Tige de poussoir de remise à zéro 4,95 mm	Nullstellwelle 4,95 mm	Pusher stem for zero action 4.95 mm
093ST0023		Tige de poussoir de remise à zéro 3,75 mm	Nullstellwelle 3,75 mm	Pusher stem for zero action 3.75 mm
093ST0024		Rallonge 0,35 mm	Verlängerung 0,35 mm	Extension 0.35 mm
093ST0025		Rallonge 0,75 mm	Verlängerung 0,75 mm	Extension 0.75 mm
093ST0026		Rallonge 1,25 mm	Verlängerung 1,25 mm	Extension 1.25 mm
0000	2033	Vis de pont de chronographe	Schraube für Chronographbrücke	Screw for chronograph bridge
0000	2237	Vis de ressort-friction de la roue de chronographe	Schraube für Frikionsfeder für Chronograph-Zentrumrad	Screw for friction-spring for chronograph runner
0000	2243	Vis de marteau d'heures	Schraube für Stundenherzhebel	Screw for hour hammer
0000	2245	Vis de ressort-friction de pignon entraîneur	Schraube für Frikionsfeder des Mitnehmertriebes	Screw for friction-spring for driving pinion
0000	2350	Vis de ressort de sabot	Schraube für Stundenzähler-Stopphebelfeder	Screw for spring for hour recorder stop lever
0000	2351	Vis de pont de compteur d'heures	Schraube für Stundenzählerbrücke	Screw for hour recorder bridge
0000	2351	Vis de pont d'appui de cadran	Schraube für Stützbrücke des Zifferblattes	Screw for supporting bridge for dial
0000	2352	Vis de tige de poussoir de mise à zéro	Schraube für Nullstellungsdrücker	Screw for pusher stem for zero action
0000	2353	Vis d'interrupteur	Schraube für Unterbrecher	Screw for switch
0000	2353	Vis de ressort de marteau d'heures	Schraube für Stundenherzhebelfeder	Screw for hour hammer spring
0000	2354	Vis de bascule de compteur d'heures	Schraube für Wippe des Stundenzählrades	Screw for hour recorder yoke
0000	2355	Vis de sautoir de navette et ressort de marteau	Schraube für Exzenter Sperre und Herzhebelfeder	Screw for cam jumper and hammer spring
0000	2357	Vis de sabot (bloqueur du compteur d'heures)	Schraube für Stundenzähler-Stopphebel	Screw for hour recorder stop lever
0000	2358	Vis d'appui de ressort de sabot	Stützschaube Stundenzähler Stopphebelfeder	Supporting screw for spring for hour recorder stop lever
0000	2513	Vis de cœur de secondes	Schraube für Sekundenherz	Screw for second heart
0000	2515	Vis de cœur d'heures	Schraube für Stundenherz	Screw for hour heart
0000	2544	Vis de commande	Schraube für Schalthebel	Screw for operating lever
0000	2544	Vis de bascule de commande	Schraube für Schalthebelwippe	Screw for operating lever hook
0000	2544	Vis de bloqueur	Schraube für Blockierhebel	Screw for lock
0000	2545P	Vis de navette	Exzenter schraube	Screw for upper and lower cam
0000	2547	Vis de pont de roue d'embrayage	Schraube für Kupplungsradbrücke	Screw for coupling wheel bridge
0000	2548	Vis de maintien de bascule d'embrayage	Schraube zum Stützen der Kupplung	Screw for supporting coupling clutch
0000	2549	Vis de ressort d'embrayage	Schraube für Kupplungsfeder	Screw for coupling clutch spring
0000	2552	Vis sur marteau (appui du ressort)	Schraube auf Herzhebel (Stützfeder)	Screw on hammer (supporting spring)

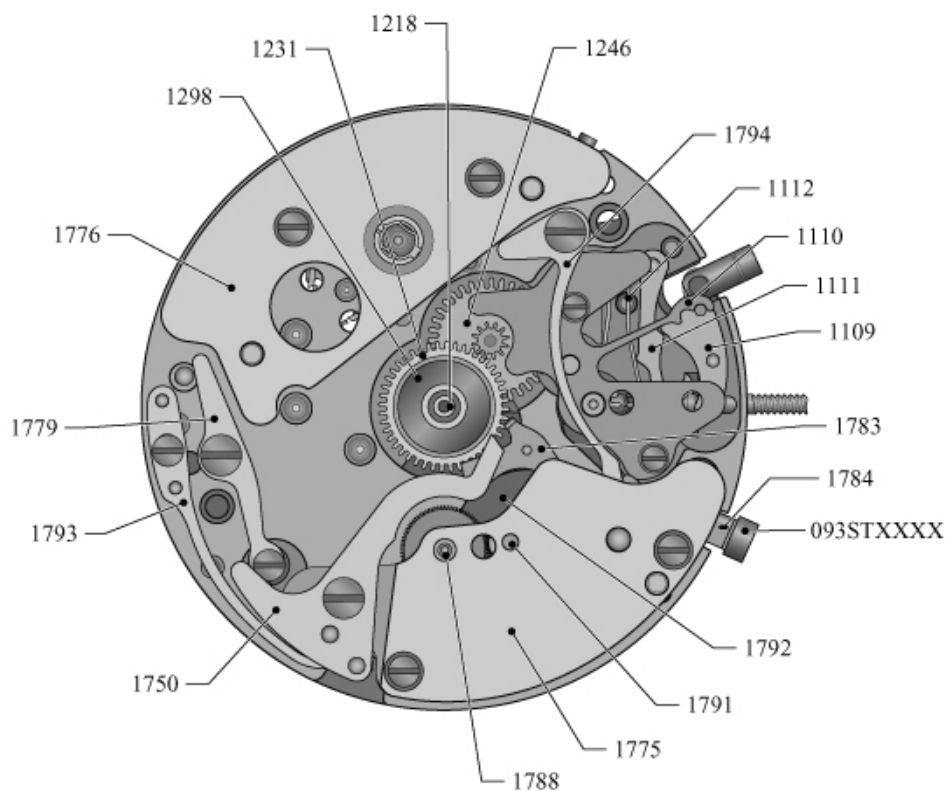
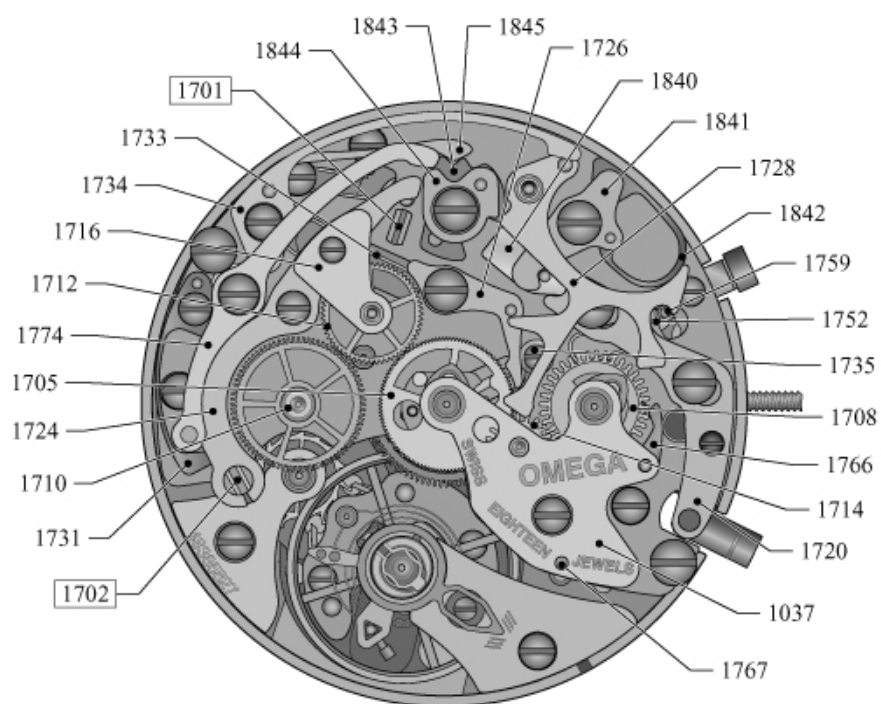

Aiguillage – Zeigerwerkhöhe – Hand fitting height

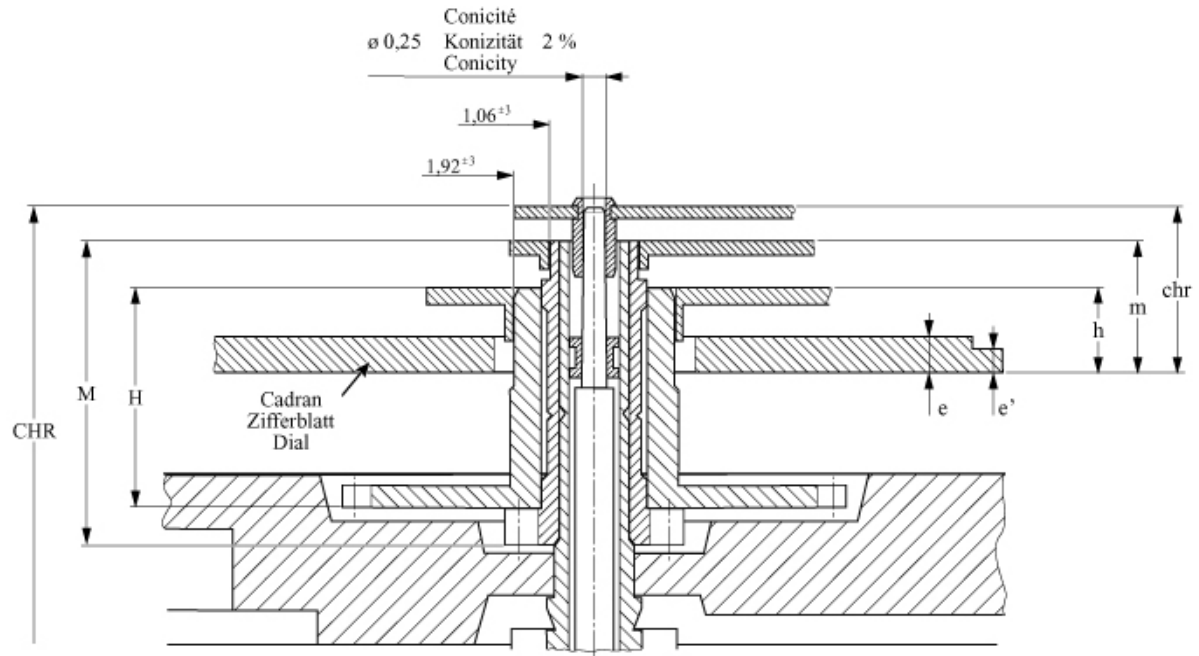

Aiguillage Zeigerwerkhöhe Hand fitting height	Longueur / Länge / Length (mm)						Dépassement en mm Höhe über Zifferblattaufgabe in mm Height over dial seat in mm								
	H	M	CHR	S	CM	CH	e	e'	h	m	chr	s	cm	ch	
	Roue des heures Stundenrad Hour wheel	Chaussée Minutenrohr Cannon pinion	Chrono Chrono	Roue de petite seconde Kleine Sekunde und Zählerrad Small second and counter wheel	Compteur minutes Minutenzähler Minutes counter	Compteur d'heures Stundenzähler Hours counter	Cadran Zifferblatt Dial	Cadran Zifferblatt Dial	Aiguille des heures Stundenzeiger Hour hand	Aiguille des minutes Minutenzeiger Minute hand	Aiguille chrono Chrono-zeiger Chrono hand	Aiguille secondes Stundenzeiger Hour hand	Compteur minutes Minutenzähler Minutes counter	Compteur d'heures Stundenzähler Hours counter	
H1	2,55	3,52	8,85	6,98	7,45	2,11	0,40	0,30	1,00	1,52	1,96	0,60	0,60	0,60	