

ETA 2893-1/2/3

TECHNICAL
COMMUNICATION

COMUNICACIÓN
TÉCNICA

COMUNICAZIONE
TECNICA

11½'''

<p>11½''' Ø 25,60 mm</p>			
<p>Movement height Altura sobre máquina 4,10 mm Altezza sopra movimento</p>	2893-1	2893-2	2893-3
<p>Power-reserve / Reserva de marcha / Riserva di marcia</p>	42 h		
<p>Number of jewels / Número de piedras / Numero di pietre</p>	21		
<p>Frequency / Frecuencia / Frequenza</p>	28'800 A/h		
<p>Lift angle of balance / Angulo de levantamiento del volante / Angolo di levata del bilanciere</p>	51°		

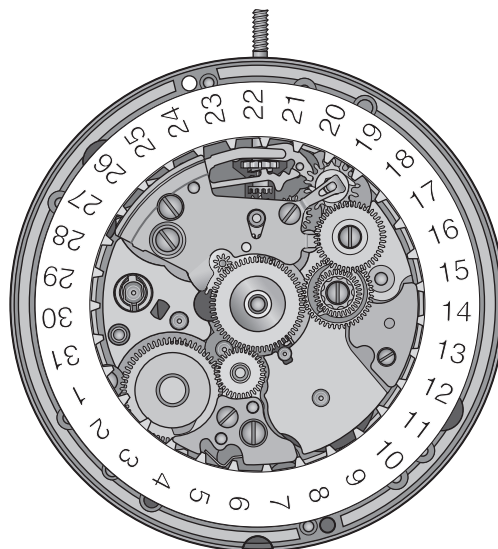
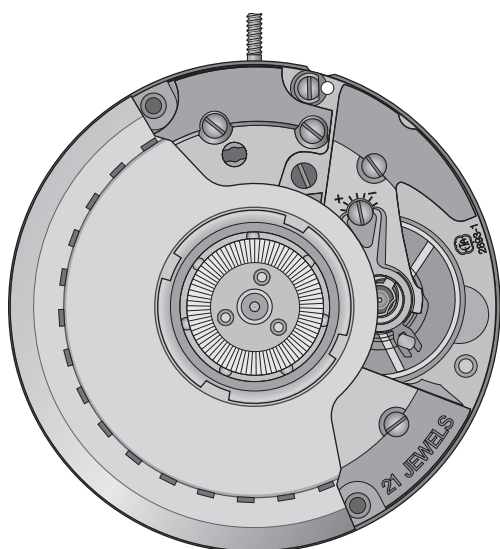

ETA SA
MANUFACTURE HORLOGÈRE SUISSE
DEPUIS 1793

Interchangeability – Intercambiabilidad – Intercambiabilità

No	No CS		LIST OF MATERIALS	LISTA DE FORNITURAS	ELENCO DELLE FORNITURE	Cal.		
						2893-1	2893-2	2893-3
100	10.020.07		Main plate, jewelled	Platina, empedrada	Piastra con pietre	2893-1	2893-2	2893-3
105	10.041.07		Barrel bridge, jewelled	Puente de cubo, empedrado	Ponte del bariletto, con pietre	2892A2	2892A2	2892A2
110	10.048.07		Train wheel bridge, jewelled	Puente de rodaje, empedrado	Ponte del ruotismo con pietre	2892A2	2892A2	2892A2
121/4	10.058.24		Balance bridge, for regulator with pointer, shock-absorber, stud support ETACHRON, corrector	Puente de volante para raqueta con flecha, amortiguador, portapitón ETACHRON, corrector	Ponte del bilanciere per racchetta a freccia, ammortizzatore, porta-pitone Etachron, correttore	2892A2	2892A2	2892A2
125	10.057.07		Pallet bridge, jewelled	Puente de áncora, empedrado	Ponte dell'ancora, con pietre	2892A2	2892A2	2892A2
144	10.300.00		Dial fastener	Sujetador de esfera	Ferma-quadrante	2892A2	2892A2	2892A2
145	10.106.00		Dial support	Soporte de esfera	Supporto del quadrante	2802	2802	2802
145/1	10.106.20		Additional dial support	Soporte de esfera suplementario	Supporto del quadrante supplementare	---	---	2893-3
161	80.400.00		Centre tube	Tubito de centro	Tubo di centro	2892A2	2892A2	2892A2
166	93.030.00	2x	Casing clamp	Brida de encajado	Brida di incassatura	2892A2	2892A2	2892A2
166/1	93.030.18	2x	Casing clamp, for waterproof case	Brida de encajado, para caja hermética	Brida di incassatura, per cassa impermeabile	2892A2	2892A2	2892A2
180/1	20.010.00		Movement barrel complete	Cubo completo de movimiento	Bariletto completo del movimento	2892A2	2892A2	2892A2
185	20.040.00		Barrel drum	Tambor de cubo	Tamburo del bariletto	2892A2	2892A2	2892A2
190	20.050.00		Barrel cover	Tapa de cubo	Coperchio del bariletto	2892A2	2892A2	2892A2
195	20.060.00		Barrel arbor	Árbol de cubo	Coperchio del bariletto	2892A2	2892A2	2892A2
203	30.012.00		Intermediate wheel	Rueda intermedia	Ruota intermedia	2892A2	2892A2	2892A2
210	30.025.00		Third wheel	Rueda primera	Ruota mediana	2892A2	2892A2	2892A2
227	30.027.00		Second wheel	Rueda de segundos	Ruota dei secondi	2892A2	2892A2	2892A2
242	31.083.00		Cannon pinion with driving wheel	Cañón de minutos con rueda de arrastre	Pignone calzante con ruota conduttrice	2892A2	2892A2	2892A2
251	31.047.00		Hour wheel 24 hrs.	Rueda de horas 24 h	Ruota delle ore 24 h	---	2893-2	---
260	31.041.00		Minute wheel	Rueda de minutería	Ruota della minuteria	2892A2	2892A2	2892A2
303/5	40.302.23		Two-piece regulator, with pointer, for stud support ETACHRON and corrector	Raqueta de 2 piezas, con flecha, para porta-pitón ETACHRON y corrector	Racchetta in 2 pezzi, a freccia, per porta-pitone ETACHRON e correttore	2892A2	2892A2	2892A2
358	40.380.00		Regular corrector	Corrector de raqueta	Correttore della racchetta	2892A2	2892A2	2892A2
375	40.200.00		Stud support, assembled	Porta-pitón, montado	Porta-pitone, montato	2892A2	2892A2	2892A2
401	51.010.21		Winding stem, thread diameter 0.90 mm	Tija de remontuar, diámetro de fileteado 0,90 mm	Albero di carica, diametro di filettatura 0,90 mm	2892A2	2892A2	2892A2
407	31.121.00		Sliding pinion	Piñón corredizo	Pignone scorrevole	2892A2	2892A2	2892A2
410	31.120.00		Winding pinion	Piñón de remontuar	Pignone di carica	2892A2	2892A2	2892A2
415	31.020.00		Ratchet wheel	Rochete	Rocchetto	2892A2	2892A2	2892A2
417	31.021.00		Intermediate ratchet wheel	Rochete intermedio	Rocchetto intermedio	2892A2	2892A2	2892A2
420	31.023.00		Crown wheel	Rueda de corona	Ruota da corona	2892A2	2892A2	2892A2
425	51.120.00		Click	Trinquete	Cricco	2892A2	2892A2	2892A2
435	51.050.00		Zoke	Báscula de piñón corredizo	Bascula del pignone scorrevole	2892A2	2892A2	2892A2
443/1	51.080.06		Setting lever, assembled	Tirete, montado	Tiretto, montato	2892A2	2892A2	2892A2
445/2	51.091.20		Combined setting lever jumper	Muelle flexible de tirete combinado	Scatto del tiretto combinato	2892A2	2892A2	2892A2
450	31.100.00		Setting wheel	Rueda de transmisión	Rinvio	2893-1	2893-1	2893-1
453	31.101.00		Intermediate setting wheel	Rueda de transmisión intermedia	Rinvio intermedio	2892A2	2892A2	2892A2
462	10.062.00		Minute train bridge	Puente de rodaje de minutería	Ponte del ruotismo di minuteria	2893-1	2893-1	2893-1
498	80.295.00		Friction washer	Arandela de fricción	Rondella di frizione	2893-1	2893-1	2893-1
511	81.086.00		Click plate	Placa de trinquete	Placca del cricco	2892A2	2892A2	2892A2
516	31.024.00		Intermediate crown wheel	Rueda de corona intermedia	Ruota della corona intermedia	2892A2	2892A2	2892A2
705	30.040.00		Escape wheel	Rueda de escape	Ruota di scappamento	2892A2	2892A2	2892A2
710	40.010.00		Pallet fork	Áncora	Ancora	2892A2	2892A2	2892A2
714	40.020.00		Pallet staff	Tija de áncora	Albero dell'ancora	2892A2	2892A2	2892A2
721	40.050.21		Timed annular balance, for shock-absorber and stud support ETACHRON	Volante anular, ajustado para amortiguador y porta-pitón ETACHRON	Bilanciere anulare, regolato per l'ammortizzatore e il porta-pitone ETACHRON	2892A2	2892A2	2892A2
728	40.100.00		Balance staff, for shock-absorber	Eje de volante, para amortiguador	Asse del bilanciere, per dispositivo ammortizzatore	2892A2	2892A2	2892A2
730	40.120.00		Double roller	Platillo doble	Doppio-disco	2892A2	2892A2	2892A2
771	20.102.00		Mainspring with sliding attachment	Muelle motor con muelle de frenado	Molla-motrice con brida di slittamento	2892A2	2892A2	2892A2

Interchangeability – Intercambiabilidad – Intercambiabilità











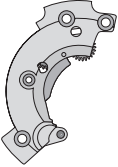







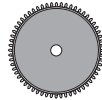































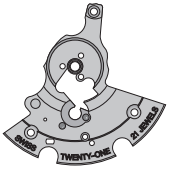
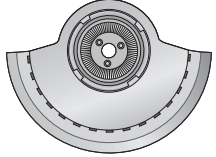





No	No CS	LIST OF MATERIALS	LISTA DE FORNITURAS	ELENCO DELLE FORNITURE	Cal.		
					2893-1	2893-2	2893-3
1134	12.030.07	Automatic device framework, jewelled	Marco del dispositivo automático, empedrado	Gabbia del dispositivo automatico, con pietre	2892A2	2892A2	2892A2
1141	12.051.07	Automatic device lower bridge, jewelled	Puente inferior del dispositivo automático, empedrado	Ponte inferiore del dispositivo automatico, con pietre	2892A2	2892A2	2892A2
1143/1	22.010.06	Oscillating weight, assembled	Masa oscilante, montada	Massa oscillante, montata	2892A2	2892A2	2892A2
1481	32.031.00	Reduction wheel	Rueda de reducción	Ruota di riduzione	2892A2	2892A2	2892A2
1482	32.033.00	Ratchet wheel driving wheel	Rueda de arrastre de rochete	Ruota conduttrice del rochetto	2892A2	2892A2	2892A2
1485	52.040.00	Reverser	Inversor	Invertitore	2892A2	2892A2	2892A2
1488	32.037.00	Reversing wheel	Rueda de inversión	Ruota d'inversione	2892A2	2892A2	2892A2
1490	32.032.00	Intermediate reduction wheel	Rueda intermedia de reducción	Ruota intermedia di riduzione	2892A2	2892A2	2892A2
1491	52.120.00	Oscillating weight bolt	Cerrojito de masa oscilante	Paletto della massa oscillante	2892A2	2892A2	2892A2
1497	22.040.00	Ball bearing	Rodamiento de bolas	Cuscinetto a sfere	2892A2	2892A2	2892A2
1514	15.041.00	Auxiliary reverser	Inversor auxiliar	Invertitore ausiliario	2892A2	2892A2	2892A2
2520/1	91.403.00	Universal hour indicator	Indicador de hora universal	Indicatore delle ore universale	2893-1	---	2893-3
2535/1	53.250.00	Date indicator maintaining small plate	Plaqueta de sujeción del indicador de fecha	Placchetta di guardia dell'indicatore del datario	2893-1	2893-1	---
2539	53.022.00	Date corrector operating lever	Mando del corrector de fecha	Comando correttore della data	2893-1	2893-1	2893-1
2543	33.011.00	Intermediate date wheel	Rueda intermedia de fecha	Ruota intermedia del datario	2892A2	2892A2	---
2556	33.020.00	Date indicator driving wheel	Rueda de arrastre del indicador de fecha	Ruota conduttrice dell'indicatore della data	2892A2	2892A2	---
2557/1	91.440.00	Date indicator, for window opening at 3 o'clock	Indicador de fecha, para apertura de ventanilla en las 3 horas	Indicatore della data, per apertura della finestrella a ore 3.00	2893-1	2893-1	---
2558	33.010.00	Double-toothed hour wheel	Rueda de horas con doble dentado	Ruota delle ore a doppia dentatura	2893-1	2893-1	2893-1
2569	53.204.00	Double corrector	Corrector doble	Correttore doppio	2893-1	2893-1	2893-1
2576	53.080.00	Date jumper	Muelle flexible de fecha	Scatta-data	2892A2	2892A2	---
2595	13.111.00	Date jumper maintaining plate	Placa de sujeción del muelle flexible de fecha	Placca di guardia dello scatta-data	2892A2	2892A2	---
3024	70.530.00	Jewelled shock-absorber for balance, top, to press-in, shouldered	Amortiguador empedrado, de volante, superior, de inserción, de asiento	Ammortizzatore con pietre, del bilanciere, sopra, a pressione, con piano di appoggio	2892A2	2892A2	2892A2
3025	70.531.00	Jewelled shock-absorber for balance, bottom, to press-in, cylindrical	Amortiguador empedrado, de volante, inferior, de inserción, cilíndrico	Ammortizzatore con pietre, del bilanciere, sotto, a pressione, cilíndrico	2892A2	2892A2	2892A2
9433	56.070.00	Stop lever	Palanquita-stop	Leva stop	2892A2	2892A2	2892A2
9565	36.025.00	Hour indicator driving wheel	Rueda de arrastre del indicador de horas	Ruota conduttrice dell'indicatore delle ore	2893-1	2893-1	2893-1
9712	36.051.00	Corrector setting wheel	Rueda de transmisión de corrector	Rinvio correttore	2893-1	2893-1	2893-1
1) 5105	10.040.01	3x Screw for barrel bridge	Tornillo de puente de cubo	Vite del ponte del bariletto	2892A2	2892A2	2892A2
5110	10.048.01	1x Screw for train wheel bridge	Tornillo de puente de rodaje	Vite del ponte del ruotismo	2892A2	2892A2	2892A2
1) 5121	10.058.01	1x Screw for balance bridge	Tornillo de puente de volante	Vite del ponte del bilanciere	2892A2	2892A2	2892A2
2) 5125	10.057.01	1x Screw for pallet bridge	Tornillo de puente de áncora	Vite del ponte dell'ancora	2892A2	2892A2	2892A2
5166	93.030.01	2x Screw for casing clamp	Tornillo de brida de encajado	Vite della brida di incassatura	2892A2	2892A2	2892A2
2) 5445	51.091.01	1x Screw for combined setting lever jumper	Tornillo de muelle flexible de tirete	Vite dello scatto del tiretto	2892A2	2892A2	2892A2
2) 5462	10.062.01	1x Screw for minute train bridge	Tornillo de puente de rodaje de minutería	Vite del ponte del ruotismo di minutería	2892A2	2892A2	2892A2
5462 ¹	10.061.01	1x Additional screw for minute train bridge	Tornillo de puente de rodaje de minutería suplementario	Vite del ponte del ruotismo di minutería supplementare	2893-1	2893-1	2893-1
5511	81.036.01	1x Screw for click plate	Tornillo de placa de trinquete	Vite della placca del cricco	2892A2	2892A2	2892A2
51134	12.030.01	3x Screw for automatic device framework	Tornillo de marco del dispositivo automático	Vite della gabbia del dispositivo automatico	2892A2	2892A2	2892A2
51141	12.051.01	1x Screw for automatic device lower bridge	Tornillo de puente inferior del dispositivo automático	Vite del ponte inferiore del dispositivo automatico	2892A2	2892A2	2892A2
51497	22.040.01	3x Screw for ball bearing	Tornillo de rodamiento de bolas	Vite del cuscinetto a sfere	2892A2	2892A2	2892A2
52535	53.250.01	1x Screw for date indicator maintaining small plate	Tornillo de plaqueta de sujeción del indicador de fecha	Vite della placchetta di fissaggio dell'indicatore della data	2893-1	2893-1	---

Interchangeability – Intercambiabilidad – Intercambiabilità

No	No CS		LIST OF MATERIALS	LISTA DE FORNITURAS	ELENCO DELLE FORNITURE	Cal.		
						2893-1	2893-2	2893-3
2)	52595	13.111.01	1x Screw for date jumper maintaining plate	Tornillo de placa de sujeción del muelle flexible de fecha	Vite della placca di guardia dello scatta-data	2893-1	2893-1	---
3)	59565	36.025.01	1x Screw for hour indicator driving wheel	Tornillo de rueda de arrastre del indicador de horas	Vite della ruota conduttrice dell'indicatore delle ore	2893-1	2893-1	2893-1
3)	59712	36.051.01	1x Screw for hour corrector setting wheel	Tornillo de rueda de transmisión del corrector	Vite del rinvio del correttore	2893-1	2893-1	2893-1
			Identical parts Fornituras idénticas Forniture identiche	1) 5105 5121 3) 59565 59712	2) 5125 5445 5462 51141 52595			









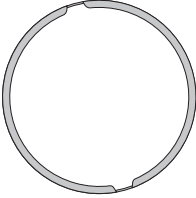

Materials - Fornituras - Forniture

2892A2



											5105 5121
105	110	121/4	125	144	161	166	166/1	180/1	185	190	5110
											5125 5445 5462 51141 52595
195	203	210	227	260	242	303/5	358	375	401		5166
											5166
407	410	415	417	420	425	435	443/1	445/2	453		5511 51497
											5166
511	516	705	710	714	721	728	730	771	1141	1134	51134
											51134
1143/1		1481	1482	1485	1488	1490	1491	1497			51497
											51497
1514	2543	2556	2576	2595	3024	3025	9433				51497

Materials - Fornituras - Forniture

2893-1 / 2893-2 / 2893-3

					
145	450	462	498	2539	
					
2558	2569	9565	9712		59565 59712

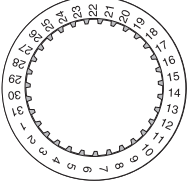
2893-1 / 2893-2

		
2535/1	2557/1	52535

2893-1

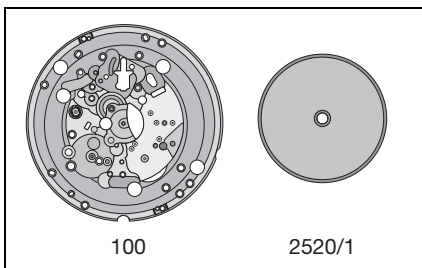

2893-2

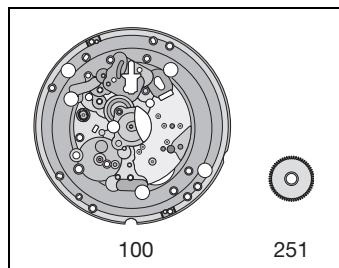

2893-3

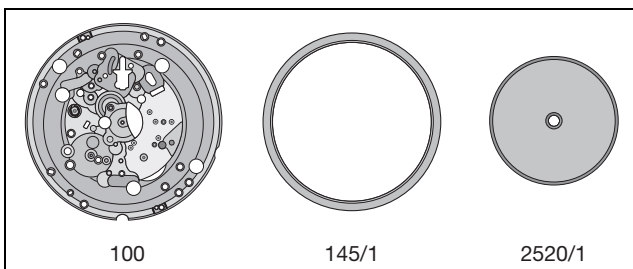

Assembling of the basic movement

(Parts listed in order of assembly)

Montaje de la máquina de base

(Lista de fornitureas por orden de ensamblado)

Montaggio del movimento di base

(Elenco delle forniture in ordine di montaggio)

100	516	5110 (1x)
161	417	710
407	425	125
410	511	5125 (1x)
401	5511 (1x)	358
3025	105	375
203	5105 (3x)	303/5
180/1	705	3024
415	210	721
1482	227	121/4
420	110	5121 (1x)

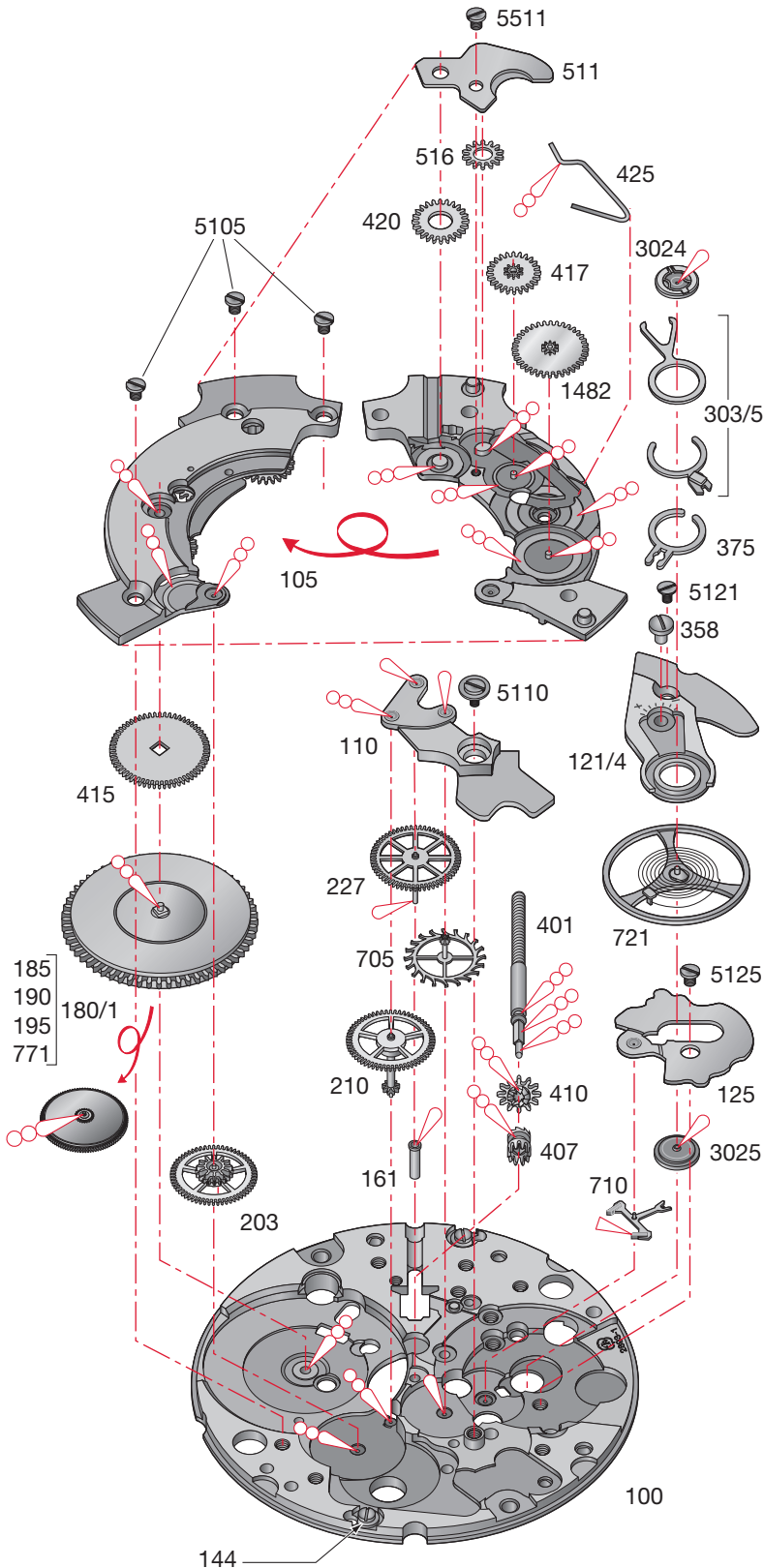

Lubrication – Lubricación – Lubrificazione

Fine oil Aceite fino Olio fluido		Moebius 9010
Thick, pressure-resistant oil or grease Aceite espeso de viscosidad elevada o grasa Olio denso a viscosità elevata o grasso		Moebius D5
Special oil for pallet stones Aceite especial para escape Olio speciale per scappamento		Moebius 941 or / ó / o Moebius 9415

No 1497 : only after washing, use very little oil Moebius 9010.

No 1497 : Sólomente después de la limpieza por lavado, muy pequeña lubricación con Moebius 9010.

No 1497 : Soltanto dopo lavaggio, lubrificazione molto lieve con Moebius 9010.



Assembling of the self-winding mechanism
(Parts listed in order of assembly)

Montaje del mecanismo automatico
(Lista de fornituras por orden de ensamblado)

Montaggio del meccanismo automatico
(Elenco delle forniture in ordine di montaggio)

9433	1141
1134	51141 (1x)
1490	1514
1481	1143/1
1488	51497 (3x)
1485	51134 (3x)

Lubrication – Lubricación – Lubrificazione

- Very little quantity
 Lubricación muy reducida **Moebius 9010**
 Lubrificazione molto lieve
- Thick, pressure-resistant oil or grease
 Aceite espeso de viscosidad elevada o grasa **Moebius D5**
 Olio denso a viscosità elevata o grasso

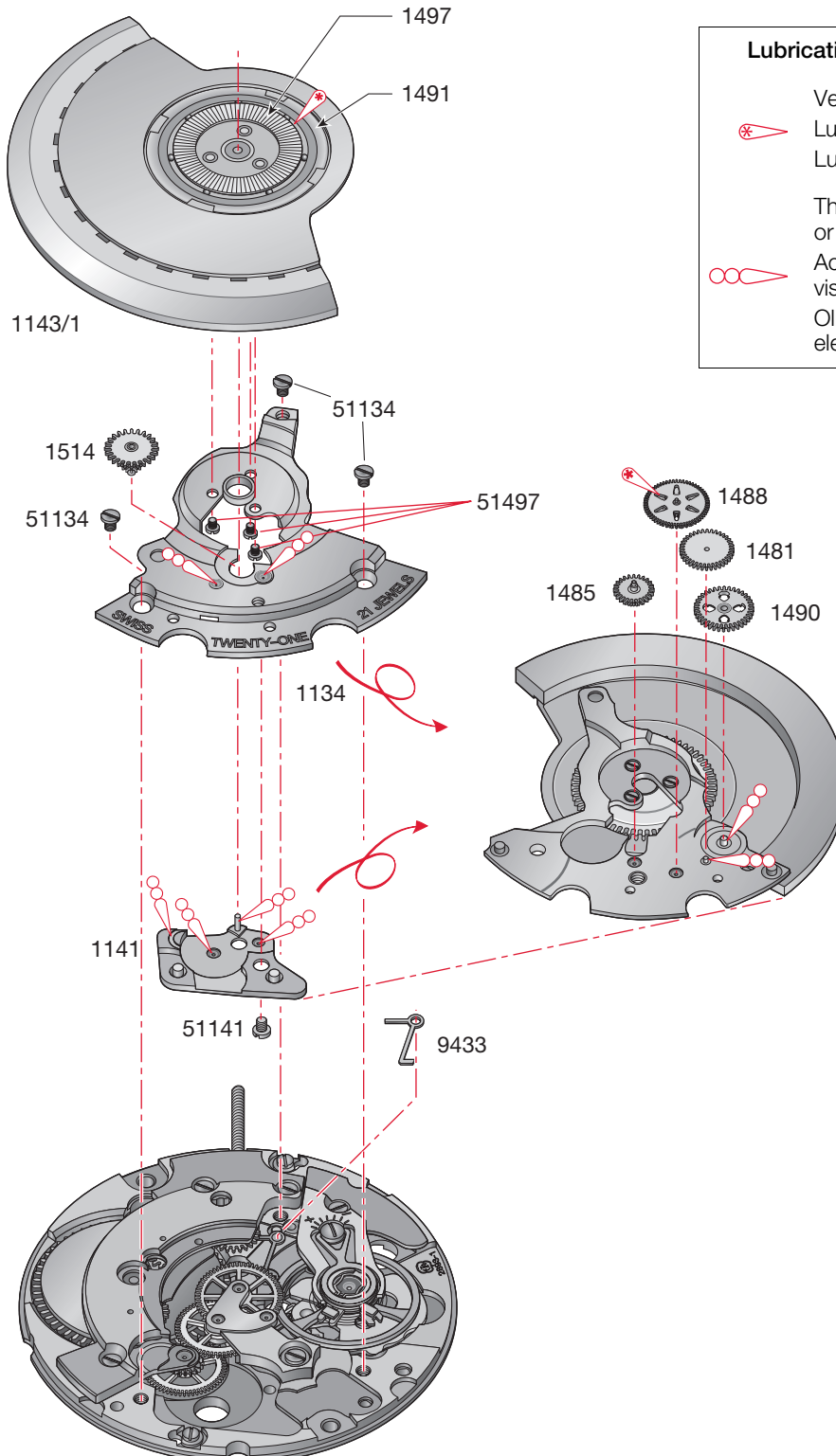

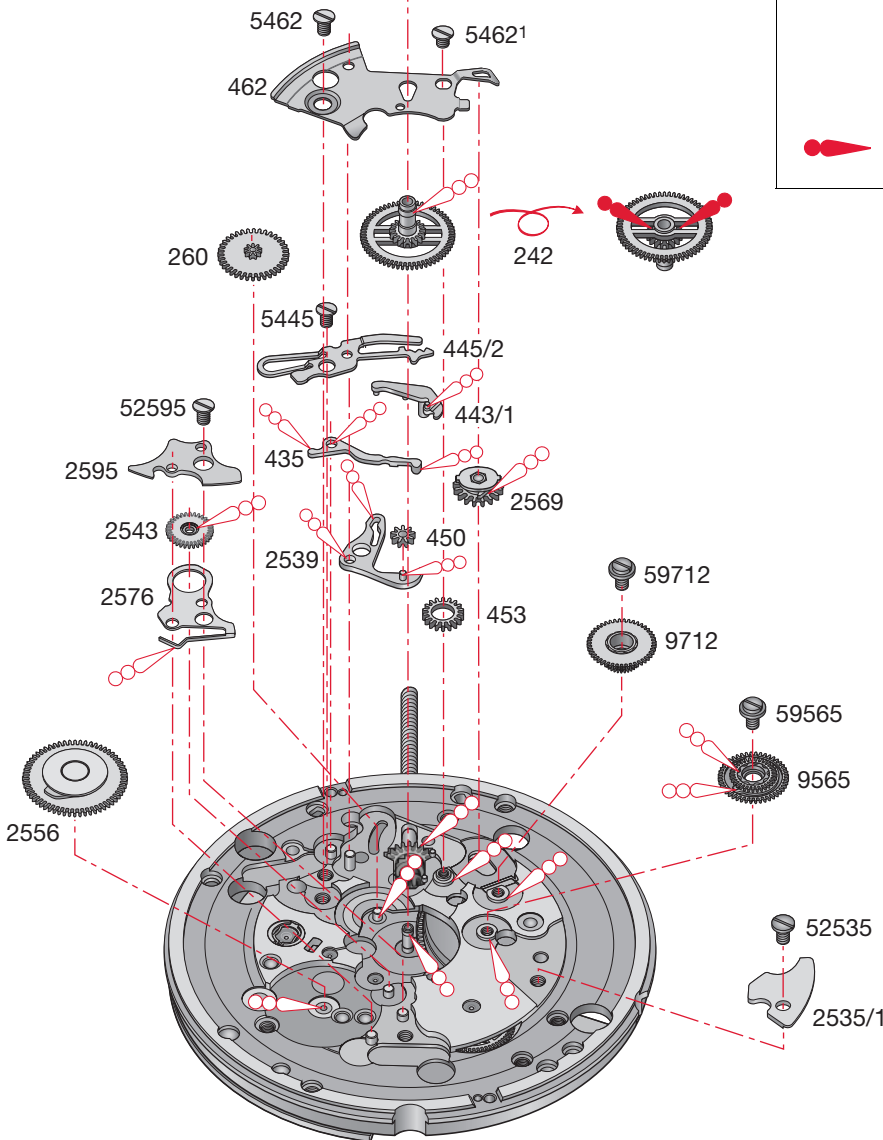
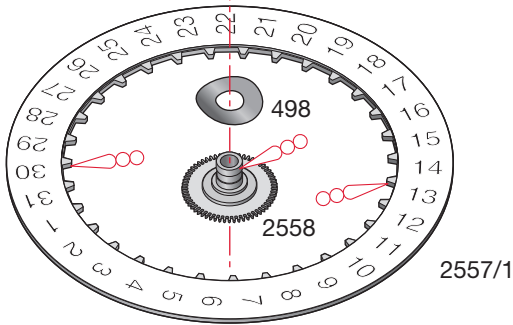
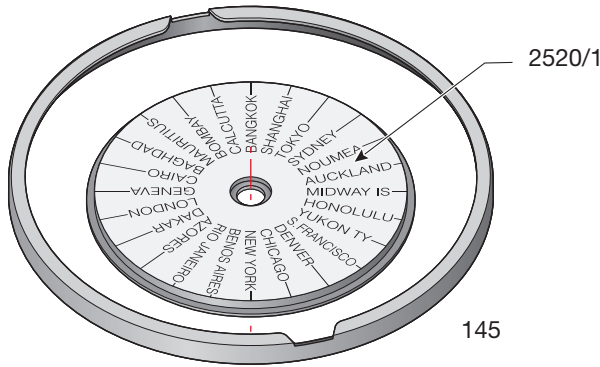

Assembling of date and universal hour mechanism

(Parts listed in order of assembly)

Montaje del mecanismo de fecha y de hora universal

(Lista de fornitures por orden de ensamblado)

Montaggio del meccanismo della data e dell'ora universale

(Elenco delle forniture in ordine di montaggio)

2539	462	52595 (1x)
443/1	5462 (1x)	9565
435	5462 ¹ (1x)	59565 (1x)
445/2	2556	9712
5445 (1x)	2557/1	59712 (1x)
242	2535/1	2558
260	52535 (1x)	498
450	2543	2520/1
453	2576	145
2569	2595	

Lubrication – Lubricación – Lubrificazione

Thick, pressure-resistant oil or grease

○ ○ ○ ○ Aceite espeso de viscosidad elevada o grasa

Moebius D5

Olio denso a viscosità elevata o grasso

● ● ● ● Grease
Grasa
Grasso

Jismaa 124
or / ó / o
Moebius 9501

Assembling of date and 24 hour hand mechanism
(Parts listed in order of assembly)

Montaje del mecanismo de fecha y aguja 24 horas
(Lista de fornitureas por orden de ensamblado)

Montaggio del meccanismo della data e lancetta delle 24 ore
(Elenco delle forniture in ordine di montaggio)

2539	462	52595 (1x)
443/1	5462 (1x)	9565
435	5462 ¹ (1x)	59565 (1x)
445/2	2556	9712
5445 (1x)	2557/1	59712 (1x)
242	2535/1	2558
260	52535 (1x)	251
450	2543	498
453	2576	145
2569	2595	

Lubrication – Lubricación – Lubrificazione

Thick, pressure-resistant oil or grease



Aceite espeso de viscosidad elevada o grasa
Olio denso a viscosità elevata o grasso

Moebius D5

Grease
Grasa
Grasso



Jismaa 124
or / ó / o
Moebius 9501

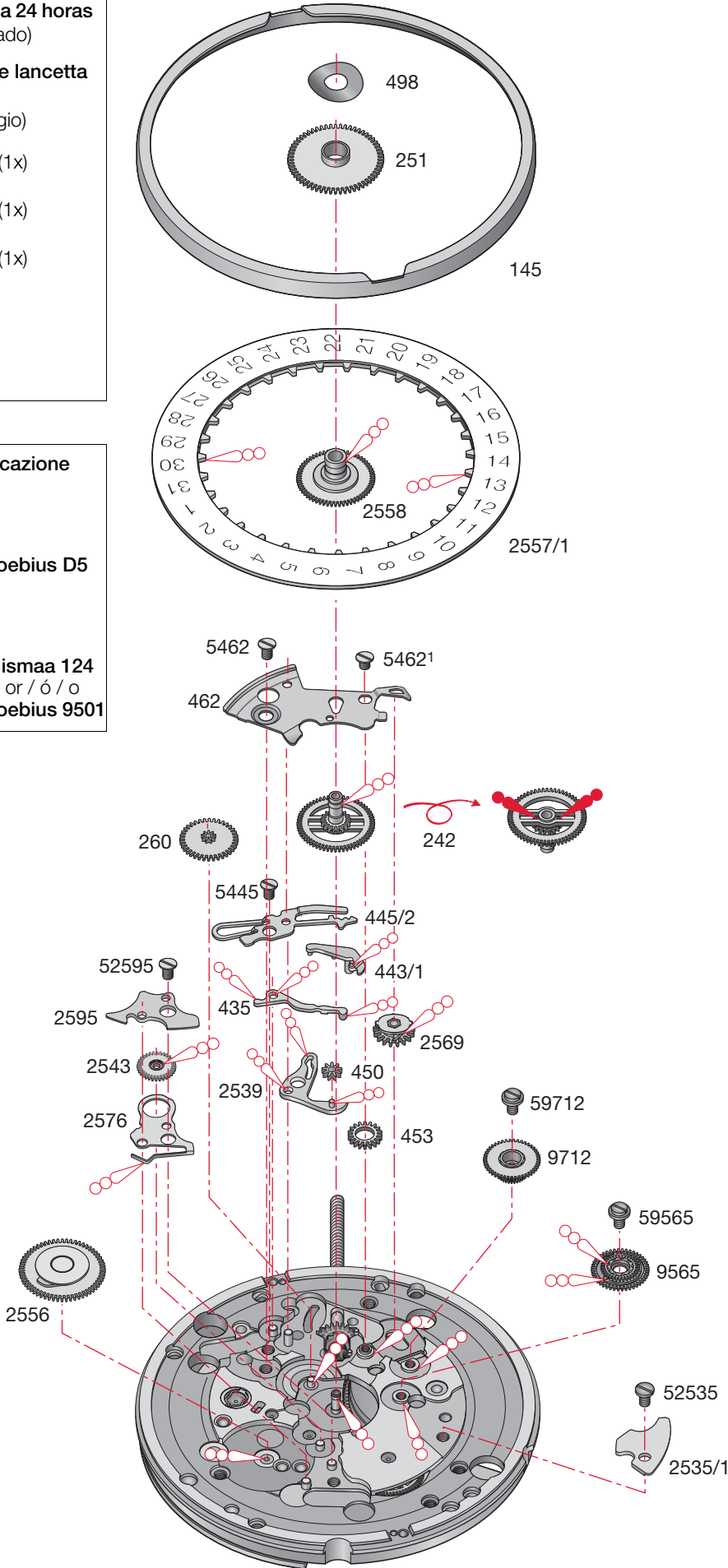

Cal. 2893-3

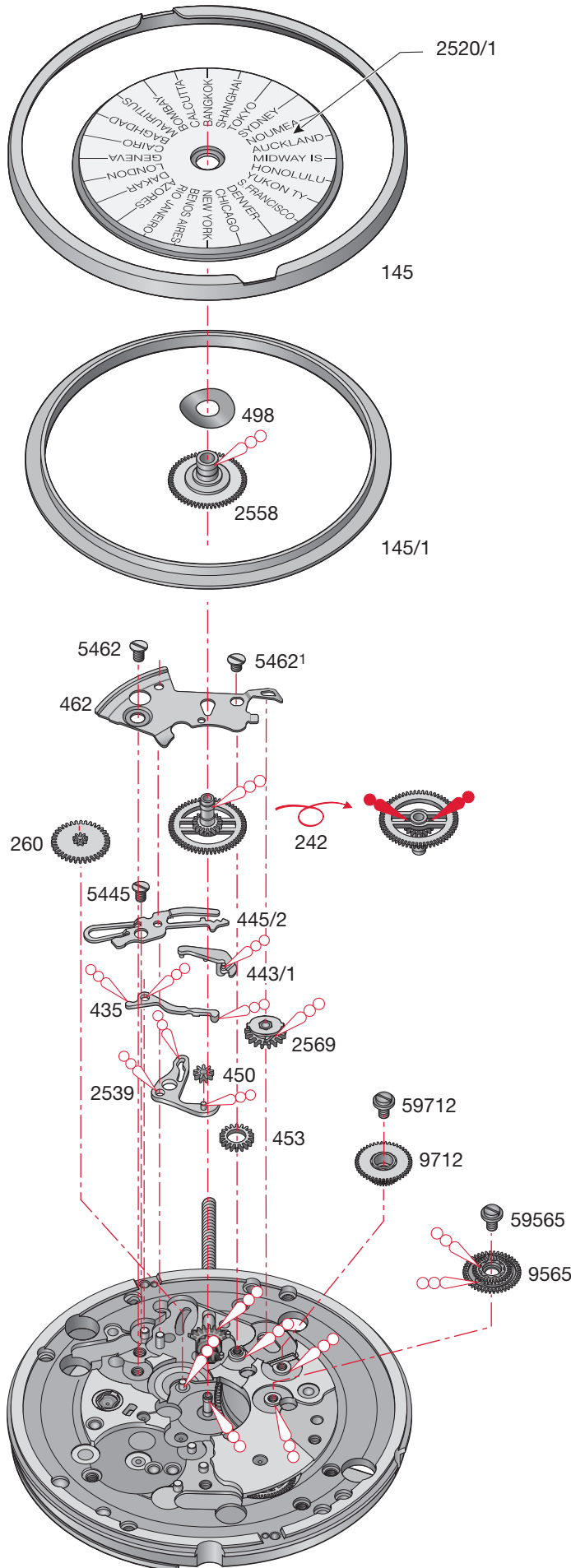



Assembling of universal hour mechanism
(Parts listed in order of assembly)

Montaje del mecanismo de hora universal
(Lista de fornitureas por orden de ensamblado)

Montaggio del meccanismo dell'ora universale
(Elenco delle forniture in ordine di montaggio)

2539	450	59565 (1x)
443/1	453	9712
435	2569	59712 (1x)
445/2	462	2558
5445 (1x)	5462 (1x)	498
242	5462 ¹ (1x)	2520/1
260	9565	145

Lubrication – Lubricación – Lubrificazione



	Thick, pressure-resistant oil or grease	
	Aceite espeso de viscosidad elevada o grasa	Moebius D5
	Olio denso a viscosità elevata o grasso	
	Grease	Jismaa 124
	Grasa	or / ó / o
	Grasso	Moebius 9501

We reserve all rights for this document. It is meant for the recipient only and it may not be copied, printed or given to a third person without our written permission.

Quedan reservados todos los derechos relacionados con este documento, que está dirigido únicamente al destinatario. Queda por lo tanto prohibida su copia, impresión o cesión a terceros sin nuestra autorización por escrito.

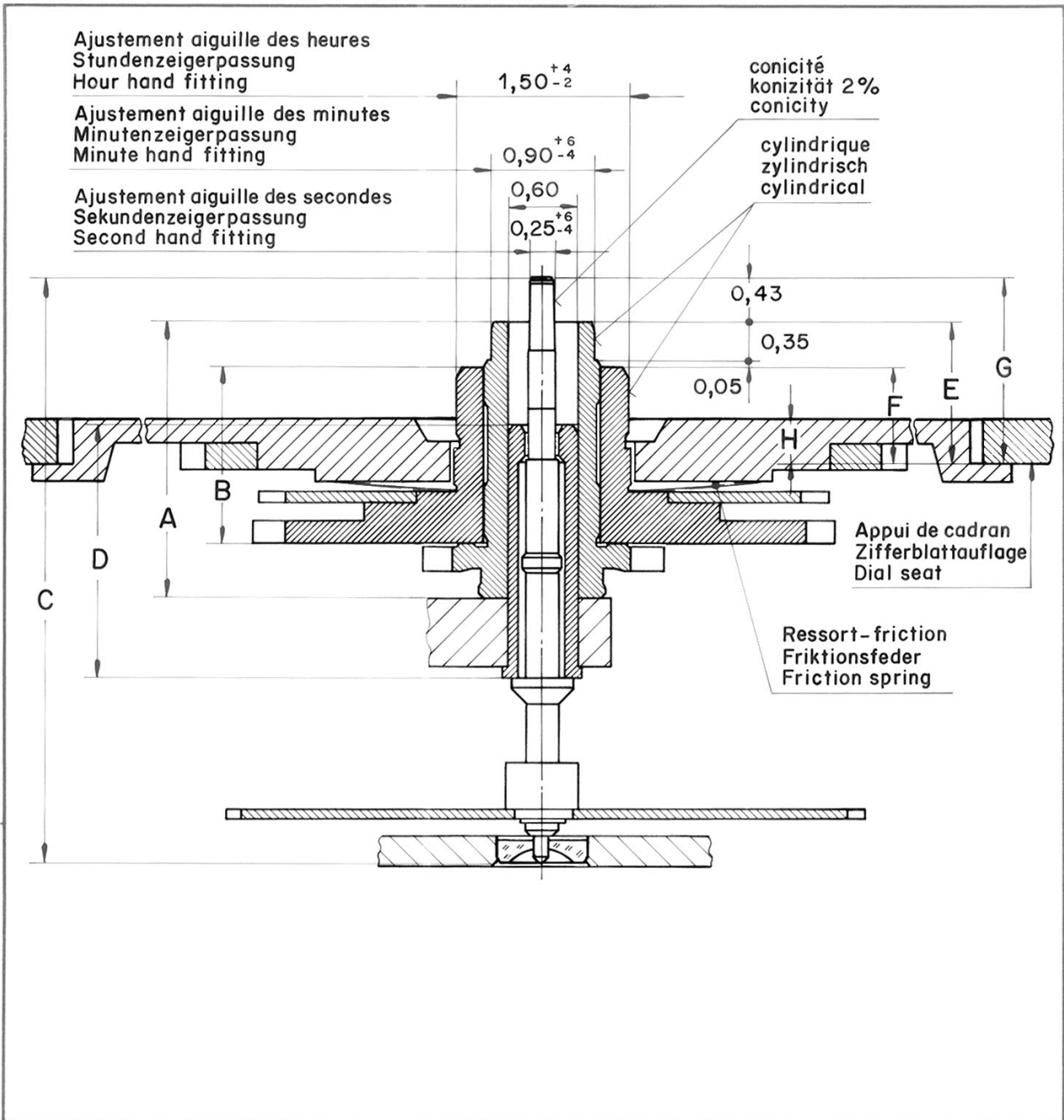
Ogni diritto su questo documento è riservato. Il documento è indirizzato esclusivamente al destinatario e non può essere copiato, stampato o ceduto a terzi senza un'autorizzazione scritta.



Aiguillage Zeigerwerk- höhe	Longueur/Länge/Length				Dépassement Höhe über Zifferblattauflage Height over dial seat			
	A	B	C	D	E	F	G	H 24h
Hand-fitting height	Chaussée Minutenrohr Cannon-pinion	Roue des heures Stundenrad Hour wheel	Pig. des sec. Sekundentrieb Sec. wheel pin.	Tube de centre Zentrumrohr Centre tube	Chaussée Minutenrohr Cannon-pinion	Roue des heures Stundenrad Hour wheel	Pig. des sec. Sekundentrieb Sec. wheel pin.	Indicat.d'heure Stundenan- zeiger Hour indicator
3	2,40	1,54	5,11	2,20	1,20	0,80	1,63	0,38
Aiguillages Zeigerwerkhöhen Hand fitting heights						Cal. 2893 - 1		
Änderungen: Modifications:				 ETA SA Fabriques d'Ebauches CH-2540 Grenchen		Masse in mm Dim. en mm Dim. in mm	Tol. in 1/1000 mm Tol. en 1/1000 mm Tol. in 1/1000 mm	 Gezeichnet: Dessiné: hm Drawn:
						Massstab: Echelle: Scale:		
						Datum: Date:	6. 9. 90	

Ajustement aiguille heure universelle
 Universalzeiger - Passung
 Universal hand fitting

Ajustement aiguille des heures
 Stundenzeigerpassung
 Hour hand fitting

Ajustement aiguille des minutes
 Minutenzeigerpassung
 Minute hand fitting

Ajustement aiguille des secondes
 Sekundenzeigerpassung
 Second hand fitting

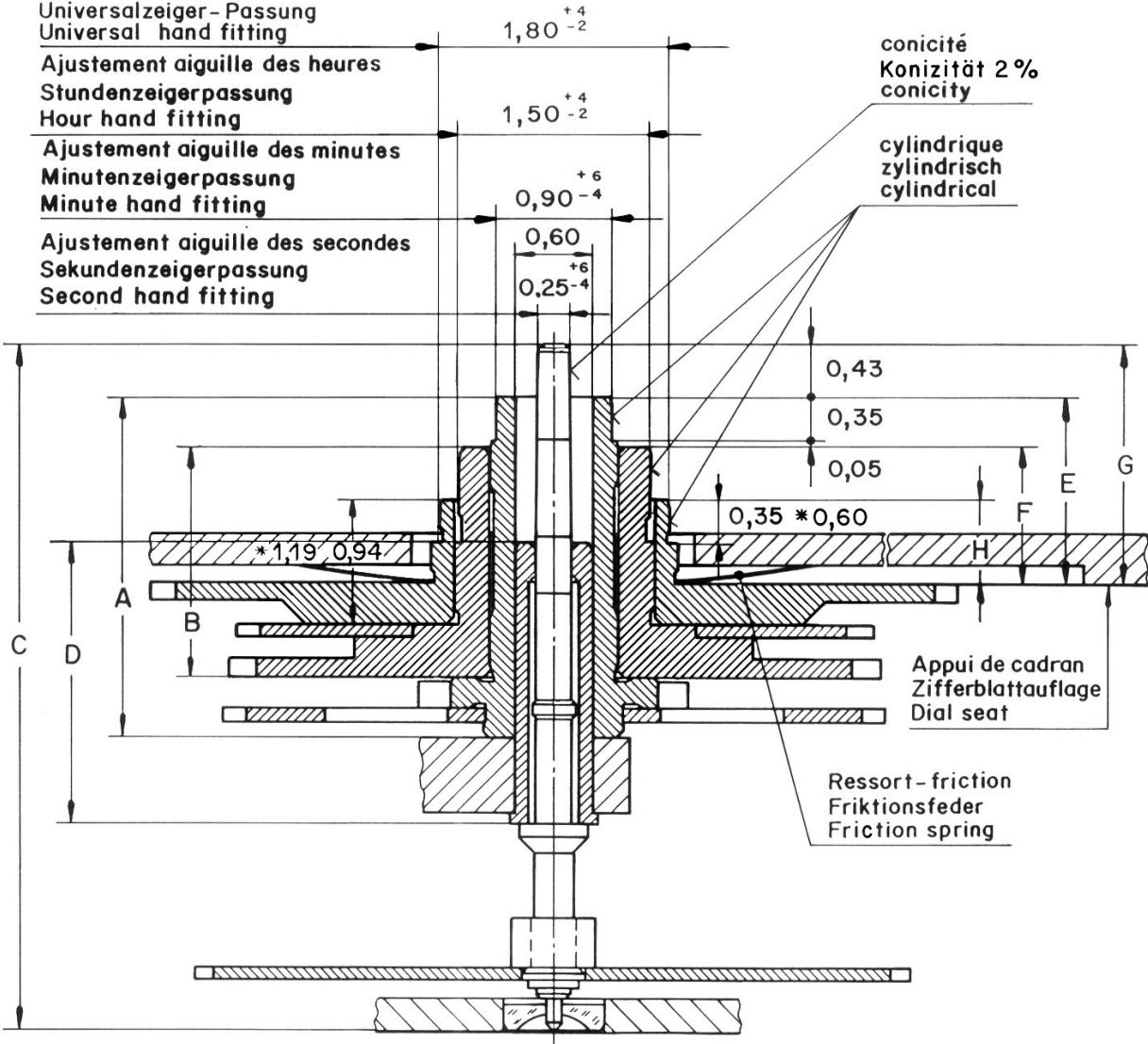

We reserve all rights for this document. It is meant for the recipient only and it may not be copied, printed or given to a third person without our written permission.

Quedan reservados todos los derechos relacionados con este documento, que está dirigido únicamente al destinatario. Queda por lo tanto prohibida su copia, impresión o cesión a terceros sin nuestra autorización por escrito.

Ogni diritto su questo documento è riservato. Il documento è indirizzato esclusivamente al destinatario e non può essere copiato, stampato o ceduto a terzi senza un'autorizzazione scritta.

Aiguillage Zeigerwerk- höhe Hand fitting height	Longueur/Länge/Length				Dépassement Höhe über Zifferblattauflage Height over dial seat			
	A	B	C	D	E	F	G	H 24 h
	Chaussée Minutenrohr Cannon-pinion	Roue des heures Stundenrad Hour wheel	Pig. des sec. Sekundentrieb Sec. wheel pin.	Tube de centre Zentrumrohr Centre tube	Chaussée Minutenrohr Cannon-pinion	Roue des heures Stundenrad Hour wheel	Pig. des sec. Sekundentrieb Sec. wheel pin.	Indicat.d'heure Stundenan- zeiger Hour indicator
4	2,65	1,79	5,36	2,20	1,45	1,05	1,88	0,65
* 5	2,90	2,04	5,61	2,20	1,70	1,30	2,13	0,90
Aiguillages Zeigerwerkhöhe Hand fitting heights					Cal. 2893-2			
Änderungen: Modifications:					Masse in mm Dim. en mm Dim. in mm	Tol. in 1/1000 mm Tol. en 1/1000 mm Tol. in 1/1000 mm		
					Masstab: Echelle: Scale:		Gezeichnet: Dessiné: Drawn: hm	
					Datum: Date:	28.6.91	Kontrolliert: Contrôle: Checked: <i>hm</i>	
				 ETA SA Fabriques d'Ebauches CH-2540 Grenchen				

We reserve all rights for this document. It is meant for the recipient only and it may not be copied, printed or given to a third person without our written permission.

Quedan reservados todos los derechos relacionados con este documento, que está dirigido únicamente al destinatario. Queda por lo tanto prohibida su copia, impresión o cesión a terceros sin nuestra autorización por escrito.

Ogni diritto su questo documento è riservato. Il documento è indirizzato esclusivamente al destinatario e non può essere copiato, stampato o ceduto a terzi senza un'autorizzazione scritta.

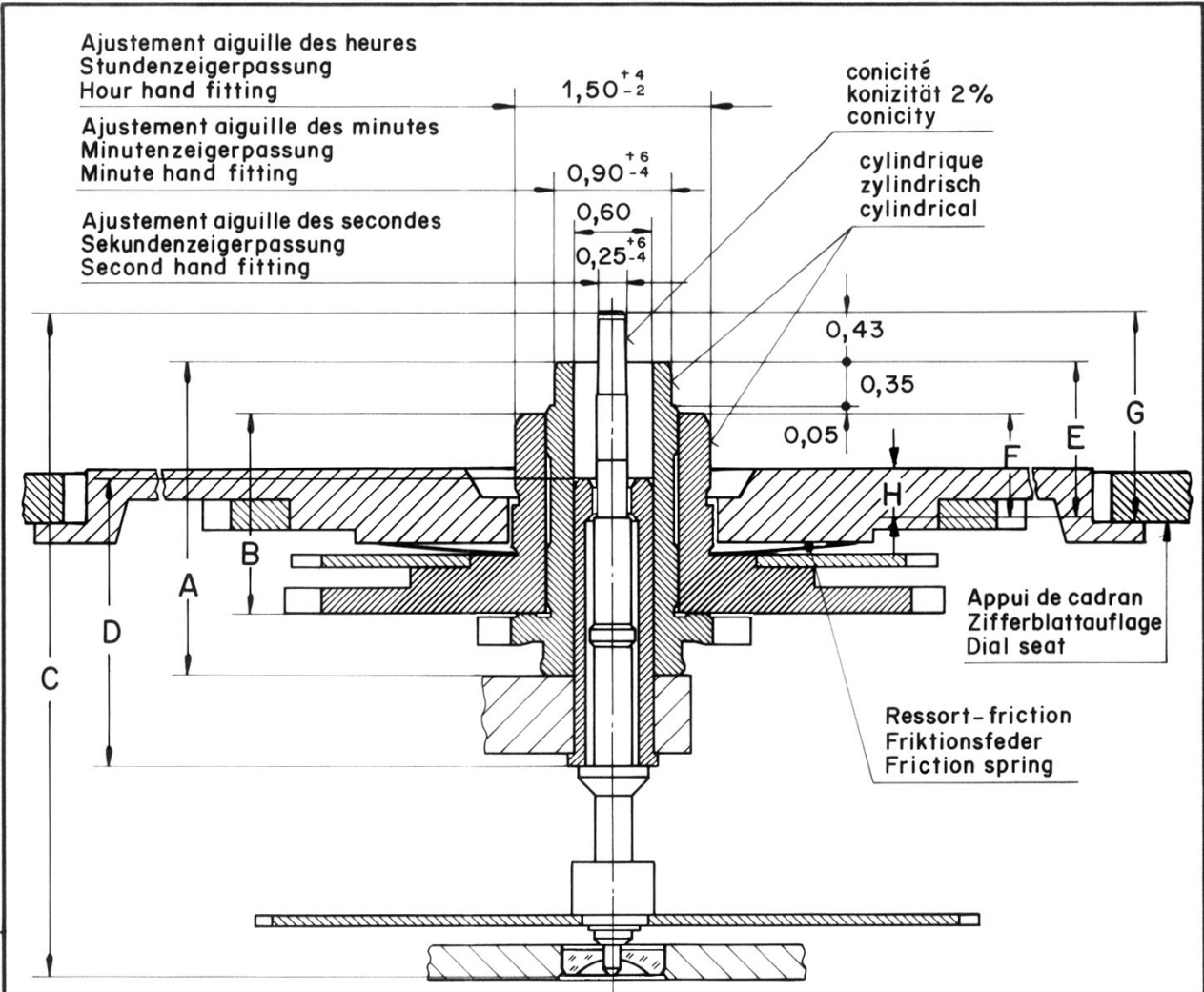

Aiguillage Zeigerwerk- höhe Hand-fitting height	Longueur/Länge/Length				Dépassement Höhe über Zifferblattauflage Height over dial seat			
	A	B	C	D	E	F	G	H 24h
3	2,40	1,54	5,11	2,20	1,20	0,80	1,63	0,42

Aiguillages
Zeigerwerkhöhen
Hand fitting heights

Cal. **2893 - 3**

Anderungen: Modifications:				<p>ETA SA Fabriques d'Ebauches CH-2540 Grenchen</p>	Masse in mm Dim. en mm Dim. in mm	Tol. in 1/1000 mm Tol. en 1/1000 mm Tol. in 1/1000 mm	<p>Gezeichnet: Dessiné: hm Drawn:</p>
					Masse in mm Dim. en mm Dim. in mm	Tol. in 1/1000 mm Tol. en 1/1000 mm Tol. in 1/1000 mm	

This page is intentionally
left blank

Página dejada en blanco
intencionadamente

Questa pagina è stata lasciata
bianca intenzionalmente

This page is intentionally
left blank

Página dejada en blanco
intencionadamente

Questa pagina è stata lasciata
bianca intenzionalmente

*Modifications compared with
previous document versions*

*Modificaciones comparadas con
las versiones anteriores del docu-
mento*

*Modifiche comparate con le versio-
ni precedenti del documento*

Version Versión Versione	Date Fecha Data	Modification	Modificación	Modifica	Page Página Pagina
03	02.04.07	Basic version	Versión de base	Versione di base	--



ETA SA
MANUFACTURE HORLOGÈRE SUISSE
DEPUIS 1793

CUSTOMER SERVICE

Bahnhofstrasse 9
P.O. Box 427
2540 Grenchen
Schweiz

Tel +41 (0)32 655 72 77
Fax +41 (0)32 655 84 30

etacs@eta.ch
www.eta.ch